

INDUSTRIAL COOLING

2016 PRODUCT CATALOGUE



RADIATORS

Radiator Assemblies 18

Kenworth Quick Reference Guide 113

Radiator Assemblies	17	Heaters	421
Charge Air Coolers	117	Radiator Caps & Filler Necks	427
Oil Coolers	155	Hose Clamps	439
Cores	181	Coolant	443
Tanks	309	Fittings	451
Gaskets & Sealing	353	Workshop Equipment	461
Air Conditioning	363	Index	473

AUSTOFT

AUSTOFT

CANE HARVESTER



Image Not Currently Available

YFW12970

Header	914 x 122	Core	Y12970/5SL5SC
O Ring/Gasket		T/B Tank	
Condenser			
Notes			

ATLAS COPCO

ATLAS COPCO

DMS COALTRAM CT10

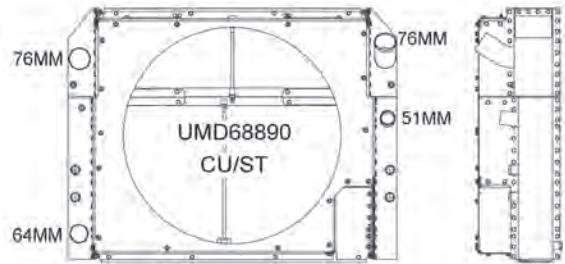

Header		Core	JW: MDF2415 / CAC: CAF2416
O Ring/Gasket		T/B Tank	
Condenser			
Notes		Radiator: 1004 x 540 x 108 CAC: 974 x 270 x 125mm	

L7 / L8 Mk2 Driller

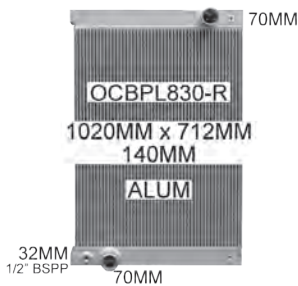

Header		Core	
O Ring/Gasket		T/B Tank	
Condenser			
Notes	Bar & Plate		

Header		Core	
O Ring/Gasket		T/B Tank	
Condenser			
Notes			

BELL

BELL

B40 Dump Truck



Header	842 x 79	Core	
O Ring/Gasket		T/B Tank	
Condenser			
Notes			

CATERPILLAR

CT630 PRIME MOVER



Header	670 x 75	Core	
O Ring/Gasket		T/B Tank	
Condenser			
Notes			

DOZER D11R

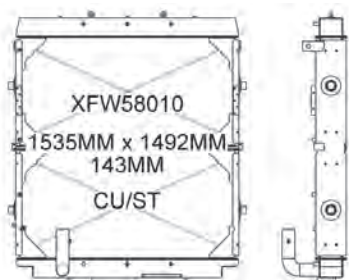

Header		Core	MLF2207 / MLF2208
O Ring/Gasket	X001045S/C6327K	T/B Tank	75801001 / 72801004
Condenser			
Notes			

EXCAVATOR 312



Header	641 x 85	Core	CAT008
O Ring/Gasket		T/B Tank	
Condenser			
Notes			

EXCAVATOR 312C



Header	641 x 85	Core	CAT008
O Ring/Gasket		T/B Tank	
Condenser			
Notes			

EXCAVATOR 320



Header	750 x 85	Core	CAT001
O Ring/Gasket		T/B Tank	
Condenser			
Notes			

EXCAVATOR 322C / 325C



Header		Core	
O Ring/Gasket		T/B Tank	
Condenser			
Notes			

MINI EXCAVATOR 304CR



Header	407 x 69	Core	CAT006
O Ring/Gasket		T/B Tank	
Condenser			
Notes	MITSUBISHI S4Q2 Engine 42HP		

CATERPILLAR

ROLLER



Header	465 x 69	Core	
O Ring/Gasket		T/B Tank	
Condenser			
Notes			

ROLLER PS / PF / CS

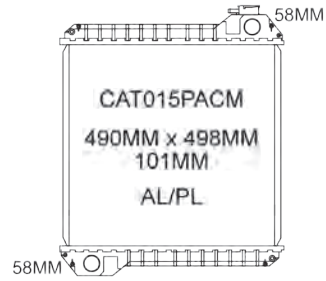

Header		Core	
O Ring/Gasket		T/B Tank	
Condenser			
Notes			

UNDERGROUND LOADER MH40

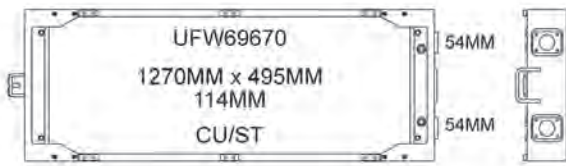

Header	520 x 125	Core	CBM803
O Ring/Gasket		T/B Tank	56967010 / 56967020
Condenser			
Notes			

Header		Core	
O Ring/Gasket		T/B Tank	
Condenser			
Notes			

CASE

CASE

BACKHOE 580L / 580M / 580SM / 590SL / 590SM



Header	528 x 124	Core	
O Ring/Gasket		T/B Tank	
Condenser			
Notes			

EXCAVATOR CX210'01-06



Header		Core	
O Ring/Gasket		T/B Tank	
Condenser			
Notes	6TAA-590 Engine		

LOADER 580L / 580M / 580SM / 590SL / 590SM



Header	528 x 124	Core	
O Ring/Gasket		T/B Tank	
Condenser			
Notes			

TRACTOR 564 / 574 / 674

Header	447 x 70	Core	IMC270
O Ring/Gasket		T/B Tank	
Condenser			
Notes			

TRACTOR MXM Auto.

Header	560 x 146	Core	
O Ring/Gasket		T/B Tank	
Condenser			
Notes			

CASE

CLARK BOBCAT

753 BOBCAT SKIDSTEER

Header	305 x 108	Core	CLA251
O Ring/Gasket		T/B Tank	CLA251BT
Condenser			
Notes	3/4 Assembly		

CLARK BOBCAT

COMPAIR

COMPAIR COMPACT RADIATOR & OIL COOLER

Header	489 x 105	Core	
O Ring/Gasket	ARO-640/SC-92K	T/B Tank	ARO-2640 / ARO-3-640
Condenser			
Notes			

COMPAIR

DAF

CF65 6.5ltr Man. '01-

Header	646 x 76	Core	
O Ring/Gasket		T/B Tank	
Condenser			
Notes			

DAF

DAF

CF75 9.2ltr Man. '01-



Header	646 x 76	Core	
O Ring/Gasket		T/B Tank	
Condenser			
Notes			

CF85 12.9ltr Man. '01-



Header	646 x 76	Core	
O Ring/Gasket		T/B Tank	
Condenser			
Notes			

XF SERIES Man. '00-06



Header	773 x 71	Core	DAF002
O Ring/Gasket	OR775X71F	T/B Tank	
Condenser			
Notes			

Header		Core	
O Ring/Gasket		T/B Tank	
Condenser			
Notes			

DENNING

DENNING

BUS

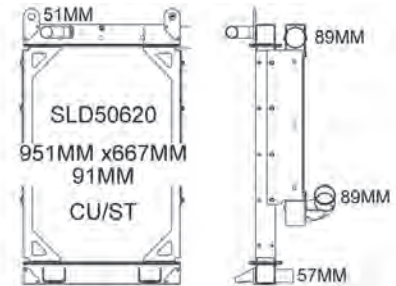

Header		Core	
O Ring/Gasket		T/B Tank	
Condenser			
Notes	Radiator & CAC Assembly		

BUS

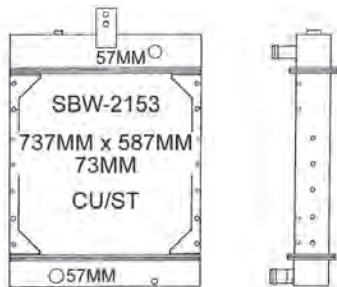

Header		Core	
O Ring/Gasket		T/B Tank	
Condenser			
Notes	Detroit 8.2ltr		

Header		Core	
O Ring/Gasket		T/B Tank	
Condenser			
Notes			

DEUTZ

TRACTOR 1012 '95-01



Header	488 x 91	Core	DEU001
O Ring/Gasket		T/B Tank	
Condenser			
Notes			

DEUTZ

DRIFTRUNNER

BRUMBY 1006-6



Header	644 x 178	Core	SMV601
O Ring/Gasket	SP-1464	T/B Tank	72018006 / 72018002
Condenser			
Notes	Perkins Engine		

DRIFTRUNNER

EIMCO

ED7

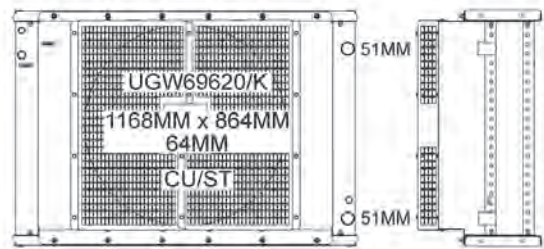

Header	942 x 180	Core	EIM710B
O Ring/Gasket	2304-115 / 2304-116	T/B Tank	2304-310 / 2304/315
Condenser			
Notes	Caterpillar 3126TA Engine / With Oil Cooler posts		

EIMCO

ED7 / ED10



Header	942 x 180	Core	EIM710B
O Ring/Gasket	2304-115 / 2304-116	T/B Tank	2304-310 / 2304/315
Condenser			
Notes	Caterpillar 3126TA Engine		

ED10

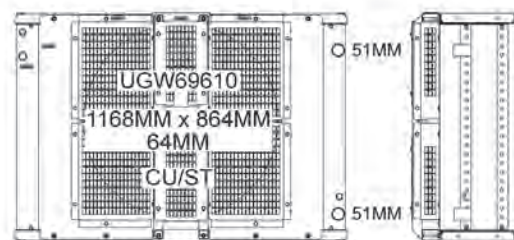

Header	942 x 180	Core	EIM710B
O Ring/Gasket	2304-115 / 2304-116	T/B Tank	2304-310 / 2304/315
Condenser			
Notes	Caterpillar 3126TA Engine		

EIMCO

ED10



Image Not Currently Available

UGW69610/K

Header	942 x 180	Core	EIM710B
O Ring/Gasket	2304-115 / 2304-116	T/B Tank	2304-310 / 2304/315
Condenser			
Notes	Caterpillar 3126TA Engine / With Oil Cooler posts		

FERGUSON

FERGUSON

TRACTOR 35



Header	397 x 120/107	Core	FER203
O Ring/Gasket		T/B Tank	FER203BT/BB
Condenser			
Notes	Bracket Located on Inlet Tank / Straight Inlet Pipe		

TRACTOR 35



Header	397 x 120/107	Core	FER203
O Ring/Gasket		T/B Tank	FER203BT/BB
Condenser			
Notes	Bracket Located on Inlet Tank / Curved Inlet Pipe		

TRACTOR MF135



Header	397 x 120/403 x 107	Core	FER205
O Ring/Gasket		T/B Tank	FER205BB
Condenser			
Notes			

TRACTOR MF165



Header	395 x 120/75	Core	FER211
O Ring/Gasket		T/B Tank	
Condenser			
Notes			

TRACTOR MF165 / MF168



Header	395 x 120/74	Core	FER214
O Ring/Gasket		T/B Tank	
Condenser			
Notes			

TRACTOR MF175 / MF178



FER214CM
487MM x 380MM
50MM 3-ROW
CU/BR

Header	395 x 120/74	Core	FER214
O Ring/Gasket		T/B Tank	
Condenser			
Notes			

TRACTOR MF185



FER214CM
487MM x 380MM
50MM 3-ROW
CU/BR

Header	395 x 120/74	Core	FER214
O Ring/Gasket		T/B Tank	
Condenser			
Notes			

TRACTOR MF185 / MF188



40MM
FER211CM
490MM X 380MM
45MM 4-ROW
CU / BR
40MM

Header	395 x 120/75	Core	FER211
O Ring/Gasket		T/B Tank	
Condenser			
Notes			

TRACTOR MF65 / MF285



FER214CM
487MM x 380MM
50MM 3-ROW
CU/BR

Header	395 x 120/74	Core	FER214
O Ring/Gasket		T/B Tank	
Condenser			
Notes			

TRACTOR TEA20



38MM Ø
FER203CM2
432MM x 384MM
50MM 3-ROW
CU / BR
34MM Ø

Header	397 x 120/107	Core	FER203
O Ring/Gasket		T/B Tank	FER203BT/BB
Condenser			
Notes	Bracket Located on Inlet Tank		

Header		Core	
O Ring/Gasket		T/B Tank	
Condenser			
Notes			

FIAT

DUCATO 2.8ltr Turbo Diesel Auto/Man. '2/02-07

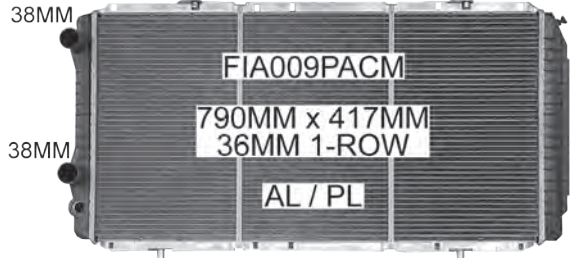

38MM
38MM
FIA009PACM
790MM x 417MM
36MM 1-ROW
AL / PL

Header	430 x 50	Core	
O Ring/Gasket		T/B Tank	
Condenser	CFIA01		
Notes	1 x Sensor Hole / External Oil Cooler		

FIAT

DUCATO 2.3ltr/3.0ltr Turbo Diesel Man. '07-

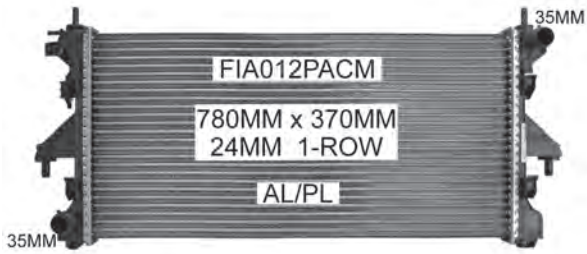

Header	395 x 56	Core	
O Ring/Gasket		T/B Tank	
Condenser			
Notes	Clip On Fittings		

TRACTOR 450 / 500 / 600 / 640



Header	460 x 98	Core	FIA244
O Ring/Gasket		T/B Tank	
Condenser			
Notes			

TRACTOR 55-66 / 60-66 / 80-66



Header	460 x 98	Core	FIA244
O Ring/Gasket		T/B Tank	
Condenser			
Notes			

Header		Core	
O Ring/Gasket		T/B Tank	
Condenser			
Notes			

FORD

FORD

AEROMAX Man.



Header	888 x 76	Core	FD8361
O Ring/Gasket		T/B Tank	FD8361BT/BB
Condenser			
Notes			

CARGO Man.

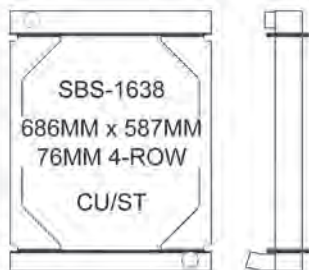

Header	644 x 140	Core	SBS-1638/4ML11
O Ring/Gasket	SP-1284	T/B Tank	
Condenser			
Notes	Caterpillar 3208 Engine		

CARGO Auto.

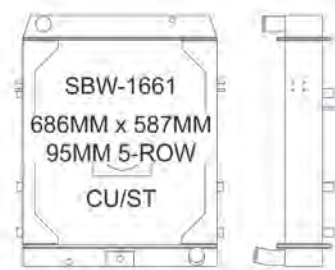

Header	644 x 178	Core	SBW-1661/5ML11
O Ring/Gasket	SP-1464	T/B Tank	
Condenser			
Notes	Caterpillar 3208 Engine / Crank Hole / Allison MT643 Trans.		

CARGO 713 Man. '81-91

Header	650 x 88	Core	FD9303
O Ring/Gasket		T/B Tank	
Condenser			
Notes			

LOUISVILLE CUMMINS 350HP Man. '94-

Header	675 x 90	Core	FD8296T
O Ring/Gasket		T/B Tank	FD8296BT
Condenser			
Notes			

LOUISVILLE CUMMINS LOW FLOW Man.

Header	742 x 78	Core	FD8341
O Ring/Gasket		T/B Tank	
Condenser			
Notes			

LOUISVILLE HI FLOW BOLT ON REPLACEMENT Man.

Header	746 x 86	Core	FD8341HD
O Ring/Gasket	FD8341HDGASKET	T/B Tank	
Condenser			
Notes			

LOUISVILLE HI FLOW BOLT ON REPLACEMENT Man.

Header	746 x 86	Core	FD8341HD
O Ring/Gasket	FD8341HDGASKET	T/B Tank	
Condenser			
Notes			

LOUISVILLE LTL/LTS

Header	730 x 140	Core	VLF1103 / FD8407
O Ring/Gasket	SP-1286	T/B Tank	
Condenser			
Notes	Louisville 365hp Max / Cummins OAC Only / Steel Tanks		

STERLING HN80 / LT / AT9500 Man.

Header	888 x 76	Core	FD8361
O Ring/Gasket		T/B Tank	FD8361BT/BB
Condenser	CFOR63		
Notes			

STERLING HN80 / LT9500 Man.

Header	888 x 76	Core	FD8361
O Ring/Gasket		T/B Tank	FD8361BT/BB2
Condenser	CFOR63		
Notes			

FORD

STERLING HX7500 Auto. '07-



Header	Core
O Ring/Gasket	T/B Tank
Condenser	
Notes	

STERLING HX9500 / LX9500 Auto. '08-



Header	996 x 89	Core
O Ring/Gasket		T/B Tank
Condenser		
Notes		

STERLING LT7500 Man.



Image Not Currently Available

FRE016PACM

Header	Core
O Ring/Gasket	T/B Tank
Condenser	
Notes	

STERLING LT9500 Man.



Header	835 x 87	Core	FRE002
O Ring/Gasket	OR835X87R	T/B Tank	FRE002PT/PB
Condenser			
Notes			

STERLING LT9500 Auto.



Header	835 x 87	Core	FRE002
O Ring/Gasket	OR835X87R	T/B Tank	FRE002PT/PB
Condenser			
Notes			

STERLING LT9500 Man.



Header	996 x 89	Core
O Ring/Gasket		T/B Tank
Condenser		
Notes		

STERLING LT9599 Man. '06-



Header	1040 x 87	Core
O Ring/Gasket		T/B Tank
Condenser		
Notes		

STERLING LX7500 Auto. '07-



Header	Core
O Ring/Gasket	T/B Tank
Condenser	
Notes	

STERLING Auto.







Image Not Currently Available

FRE015PACA

Header	Core
O Ring/Gasket	T/B Tank
Condenser	
Notes	

STERLING Man.



Header	835 x 86	Core	
O Ring/Gasket	OR835X87R	T/B Tank	
Condenser			
Notes			

TRADER Man.



Header	504 x 52	Core	MAZ029
O Ring/Gasket		T/B Tank	
Condenser			
Notes			

TRANSIT VAN Auto. '86-93



Header	340 x 62	Core	FD014PA
O Ring/Gasket	OR339X63R	T/B Tank	FD014PT
Condenser			
Notes			

TRANSIT VAN Man. '86-93



Header	339 x 62	Core	
O Ring/Gasket		T/B Tank	
Condenser			
Notes			

TRANSIT VE/VF/VG 2.5ltr Diesel Auto. '94-00



Header	372 x 63	Core	FD031
O Ring/Gasket		T/B Tank	
Condenser	CFOR41 / 51		
Notes			

TRANSIT VF/VG 2.5ltr Diesel Man. '5/96-00



Header	372 x 63	Core	FD031
O Ring/Gasket		T/B Tank	
Condenser	CFOR41 / 51		
Notes			

TRANSIT VF/VG 2.0ltr EFI Man. '96-00



Header	372 x 63	Core	FD031
O Ring/Gasket		T/B Tank	
Condenser	CFOR41 / 51		
Notes			

FORD

TRANSIT VF/VG 2.5ltr Turbo Diesel Man. '5/96-00



Header	372 x 63	Core	
O Ring/Gasket		T/B Tank	
Condenser	CFOR41 / 51		
Notes			

TRANSIT VH/VJ 2.3ltr Petrol Auto/Man. '00-06

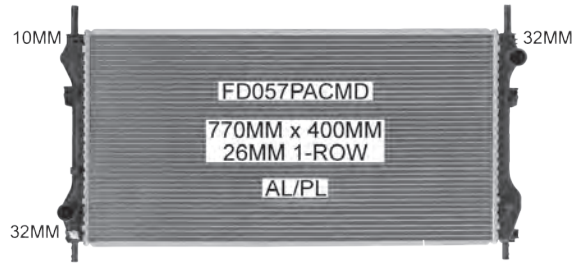

Header	406 x 49	Core	FD069PA
O Ring/Gasket	OR407X46R	T/B Tank	FD057PT
Condenser	CFOR58		
Notes	External Oil Cooler		

TRANSIT VH/VJ 2.4ltr Turbo Diesel Auto/Man. '00-06

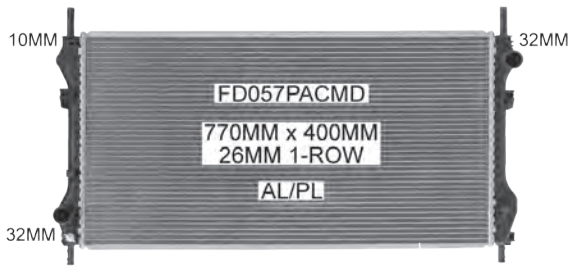

Header	406 x 49	Core	FD069PA
O Ring/Gasket	OR407X46R	T/B Tank	FD057PT
Condenser	CFOR58		
Notes	External Oil Cooler		

TRANSIT VH/VJ 2.4ltr Turbo Diesel Auto/Man. '00-06



Header	405 x 48	Core	
O Ring/Gasket	OR407X46R	T/B Tank	
Condenser	CFOR58		
Notes	External Oil Cooler / Vehicles without A/C		

TRANSIT VM Man. '9/06-

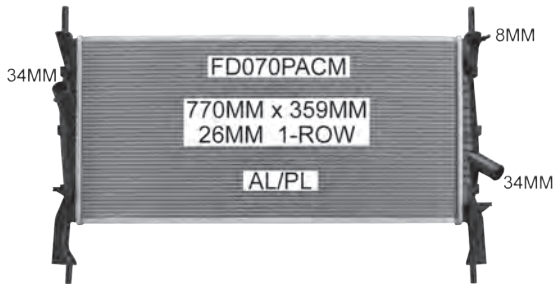

Header	388 x 44	Core	
O Ring/Gasket		T/B Tank	
Condenser	CFOR70K		
Notes	Suits Petrol & Diesel Engines		

Header		Core	
O Ring/Gasket		T/B Tank	
Condenser			
Notes			

FORDSON

FORDSON

TRACTOR 3000/5000



Header	450 x 103/74	Core	FSN211
O Ring/Gasket		T/B Tank	
Condenser			
Notes			

TRACTOR 3000/5000



38MM Ø
FSN210CM
405MM x 440MM
50MM 4-ROW
CU / BR
45MM Ø

Header	451 x 103/76	Core	FSN210
O Ring/Gasket		T/B Tank	FSN210BT/BB
Condenser			
Notes			

TRACTOR F5000



38MM
FSN207CM
455MM X 440MM
40MM 2-ROW
CU / BR
44MM

Header	450 x 100/74	Core	FSN207
O Ring/Gasket		T/B Tank	
Condenser			
Notes			

FREIGHTLINER

ARGOSY Man. '99-11

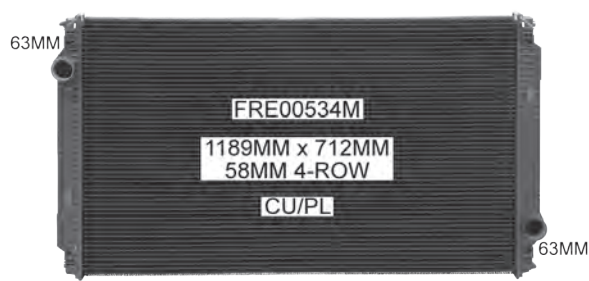

63MM
FRE00534M
1189MM x 712MM
58MM 4-ROW
CU/PL
63MM

Header	737 x 90	Core	FRE005
O Ring/Gasket	OR732X88R	T/B Tank	FRE005PT/PB
Condenser	CFRE04		
Notes	Heavy Duty		

ARGOSY Man. '99-11



10MM
64MM
FRE005PACM
1192MM x 665MM
52MM 2-ROW
AL/PL
64MM

Header	732 x 88	Core	FRE005PA
O Ring/Gasket	OR732X88R	T/B Tank	FRE005PT/PB
Condenser	CFRE04		
Notes			

ARGOSY Man. '99-11



64MM
FRE005PACMB
1194MM x 668MM
50MM 2-ROW
AL/PL
64MM

Header	732 x 88	Core	FRE005PA
O Ring/Gasket	OR732X88R	T/B Tank	FRE005PT/PB
Condenser	CFRE04		
Notes			

ARGOSY Man. '99-11



64MM
FRE005ACM
1194MM x 669MM
48MM 2-ROW
ALUM
64MM

Header	732 x 88	Core	
O Ring/Gasket		T/B Tank	
Condenser	CFRE04		
Notes	One Shot Aluminium		

ARGOSY Man. '12-



64MM
FRE015PACM
1349MM x 788MM
56MM
AL/PL
64MM

Header	809 x 86	Core	
O Ring/Gasket		T/B Tank	
Condenser			
Notes			

ARGOSY Man. '12-



Image Not Currently Available

FRE815TCM

Header	814 x 77	Core	
O Ring/Gasket		T/B Tank	
Condenser			
Notes	Ultra T Core		

CENTURY CLASS CL112 / CL120 Man.



Header	835 x 87	Core	FRE002
O Ring/Gasket	OR835X87R	T/B Tank	FRE002PT/PB
Condenser			
Notes			

CENTURY CLASS CL112 / CL120 Man.



Header	835 x 87	Core	FRE002
O Ring/Gasket	OR835X87R	T/B Tank	FRE002PT/PB
Condenser			
Notes			

CENTURY CLASS Man. '03-



Header	1032 x 86	Core	
O Ring/Gasket		T/B Tank	
Condenser	CFRE01		
Notes			

CENTURY CLASS Man. '06-



Header	835 x 86	Core	
O Ring/Gasket		T/B Tank	
Condenser			
Notes			

CENTURY CLASS Man. '09-



Header	835 x 90	Core	
O Ring/Gasket		T/B Tank	
Condenser			
Notes			

CENTURY CLASS Man.



Header	835 x 90	Core	
O Ring/Gasket		T/B Tank	
Condenser	CFRE01		
Notes			

CENTURY CLASS Auto.



Header	996 x 86	Core	
O Ring/Gasket		T/B Tank	
Condenser	CFRE01		
Notes	MBE Engine		

CENTURY CLASS Auto.

Header	996 x 86	Core	
O Ring/Gasket		T/B Tank	
Condenser	CFRE01		
Notes	Detroit Engine		

CENTURY CLASS CST112 Man. '10-

Header	1076 x 85	Core	
O Ring/Gasket		T/B Tank	
Condenser			
Notes	Detroit DD13 Engine		

COLUMBIA CLASS Man. '03-

Header	835 x 90	Core	
O Ring/Gasket		T/B Tank	
Condenser			
Notes			

COLUMBIA CL112 Man. '04-

Header	835 x 90	Core	
O Ring/Gasket		T/B Tank	
Condenser			
Notes			

COLUMBIA CL112 Auto. '11-

Header		Core	
O Ring/Gasket		T/B Tank	
Condenser			
Notes			

COLUMBIA CLASS Man. '05-

Header	835 x 90	Core	
O Ring/Gasket		T/B Tank	
Condenser	CFRE05		
Notes			

COLUMBIA Auto. '09-

Header	996 x 89	Core	
O Ring/Gasket		T/B Tank	
Condenser	CFRE05		
Notes			

COLUMBIA Man. '04-

Header	835 x 86	Core	
O Ring/Gasket		T/B Tank	
Condenser			
Notes			

FREIGHTLINER

COLUMBIA Man.



Header	836 x 88	Core	
O Ring/Gasket	OR835X87R	T/B Tank	
Condenser			
Notes	MBE Engine		

COLUMBIA Man.



Header		Core	
O Ring/Gasket		T/B Tank	
Condenser			
Notes			

COLUMBIA Auto.



Header	996 x 86	Core	
O Ring/Gasket		T/B Tank	
Condenser			
Notes	MBE Engine		

CORONADO Man. '11-



Header	1076 x 85	Core	
O Ring/Gasket		T/B Tank	
Condenser			
Notes	CUMMINS ISX Engine		

CORONADO Man. '11-



Header	1076 x 85	Core	
O Ring/Gasket		T/B Tank	
Condenser			
Notes	Detroit DD15 Engine		

CORONADO Man. '11-



Header	1040 x 84	Core	
O Ring/Gasket		T/B Tank	
Condenser			
Notes			

CORONADO Auto. '11-



Header	996 x 86	Core	
O Ring/Gasket		T/B Tank	
Condenser			
Notes	MBE Engine		

FL80 Man.



Header	644 x 83	Core	FRE9001HD
O Ring/Gasket	FRE9001HDGASKET	T/B Tank	
Condenser			
Notes			

FL80 Man.

Header	647 x 77	Core	FRE001
O Ring/Gasket	OR644X77F	T/B Tank	FRE001PT/PB
Condenser			
Notes			

FL112 Man.

Header	806 x 91	Core	FRE9002HD
O Ring/Gasket	FRE9002HDGASKET	T/B Tank	
Condenser	CFRE02 / 03		
Notes			

FL112 Man.

Header	835 x 87	Core	FRE002
O Ring/Gasket	OR835X87R	T/B Tank	FRE002PT/PB
Condenser	CFRE02 / 03		
Notes			

FL112 Man.

Header	835 x 87	Core	FRE002
O Ring/Gasket	OR835X87R	T/B Tank	FRE002PT/PB
Condenser	CFRE02 / 03		
Notes			

FL112 Man.

Header	733 x 88	Core	FRE004
O Ring/Gasket		T/B Tank	
Condenser	CFRE02 / 03		
Notes			

FLC120 Man. '09-

Header	835 x 90	Core	
O Ring/Gasket		T/B Tank	
Condenser			
Notes			

FLD112 / 120 CLASS Man.

Header	887 x 80	Core	FRE801
O Ring/Gasket		T/B Tank	
Condenser			
Notes			

Header		Core	
O Ring/Gasket		T/B Tank	
Condenser			
Notes			

HINO

300 Series Man. '09-



Header	656 x 67	Core	HIN001
O Ring/Gasket	OR657X67R	T/B Tank	HIN001PT/PB
Condenser			
Notes			KOYORAD

500 Series FD8J Man. '07-



Header	659 x 55	Core	
O Ring/Gasket	OR659X55S	T/B Tank	
Condenser			
Notes			KOYORAD

500 Series FG Man. '07-



Header	658 x 55	Core	HIN003
O Ring/Gasket	OR659X55S	T/B Tank	HIN003PT2/PB2
Condenser			
Notes			KOYORAD

500 Series GH Man. '07-10



Header	658 x 55	Core	HIN003
O Ring/Gasket	OR659X55S	T/B Tank	
Condenser			
Notes			

500 Series Man. '11-

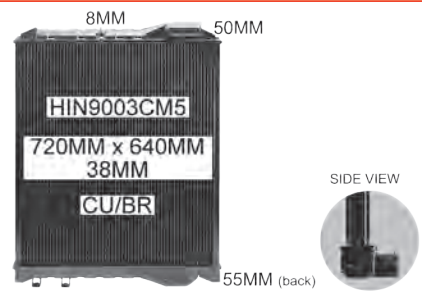

Header	660 x 70	Core	
O Ring/Gasket		T/B Tank	
Condenser			
Notes	Euro 5 Spec Engine		

700 Series Man. '03-



Header	796 x 66	Core	
O Ring/Gasket		T/B Tank	
Condenser			
Notes			

700 Series FS Man.



Header	756 x 66	Core	HIN005
O Ring/Gasket	OR758X67R	T/B Tank	HIN005PT
Condenser			
Notes			KOYORAD

700 Series Man. '11-

Header	660 x 70	Core	
O Ring/Gasket		T/B Tank	
Condenser			
Notes	Euro 5 Spec Engine		

BUS AK176 Man. '86-91

Header	660 x 98	Core	HIN923
O Ring/Gasket		T/B Tank	
Condenser			
Notes			

DUTRO 300 Series XZU302 Man. '01-02

Header	494 x 69	Core	
O Ring/Gasket	OR495X66R	T/B Tank	
Condenser			
Notes	15B Engine		

DUTRO 300 Series Man. '03-

Header	494 x 69	Core	
O Ring/Gasket	OR495X66R	T/B Tank	
Condenser			
Notes			

DUTRO 300 Series Auto. '05-07

Header	581 x 54	Core	HIN078PA
O Ring/Gasket	OR582X55S	T/B Tank	HIN078PT
Condenser			
Notes			

DUTRO 300 Series Man. '05-07

Header	581 x 54	Core	HIN078PA
O Ring/Gasket	OR582X55S	T/B Tank	HIN078PT/PB
Condenser			
Notes			

DUTRO 300 Series Auto. '07-

Header	494 x 69	Core	
O Ring/Gasket	OR495X66R	T/B Tank	HIN007PT
Condenser			
Notes	4.0ltr Turbo Diesel		

DUTRO 300 Series Man. '07-

Header	494 x 69	Core	
O Ring/Gasket	OR495X66R	T/B Tank	HIN007PT
Condenser			
Notes	4.0ltr Turbo Diesel		

DUTRO 300 Series Man. '07-



Header	494 x 69	Core	
O Ring/Gasket	OR495X66R	T/B Tank	HIN007PT
Condenser			
Notes			

DUTRO XZU Man.



Header	659 x 55	Core	HIN003
O Ring/Gasket	OR659X55S	T/B Tank	
Condenser			
Notes			

DUTRO XZU Man. '03-07



Header	581 x 54	Core	HIN078PA
O Ring/Gasket	OR582X55S	T/B Tank	HIN078PT2/PB
Condenser			
Notes	XZU414 / XZU404 / XZU424 / XZU434		

DUTRO XZU400/410 Man. '99-02



Header	582 x 55	Core	
O Ring/Gasket		T/B Tank	
Condenser			
Notes			

DUTRO XZU411 Auto. '00-03



Header	582 x 55	Core	
O Ring/Gasket		T/B Tank	
Condenser			
Notes			

GD3 Man. '91-97



Header	648 x 88	Core	
O Ring/Gasket		T/B Tank	
Condenser			
Notes			

KL300 Man. '79-84



Header	500 x 120	Core	
O Ring/Gasket		T/B Tank	
Condenser			
Notes			

KR300 Man. '71-81



Header	500 x 120	Core	
O Ring/Gasket		T/B Tank	
Condenser			
Notes			

KR320 Man. '71-81



Header	571 x 128	Core	
O Ring/Gasket		T/B Tank	
Condenser			
Notes			

KT725 Man. '75-88



Header	571 x 128	Core	HIN919
O Ring/Gasket		T/B Tank	
Condenser			
Notes			

RANGER Auto. '05-07



Header	581 x 54	Core	HIN078PA
O Ring/Gasket	OR582X55S	T/B Tank	HIN078PT
Condenser			
Notes			

RANGER Man. '05-07



Header	581 x 54	Core	HIN078PA
O Ring/Gasket	OR582X55S	T/B Tank	HIN078PT/PB
Condenser			
Notes			

RANGER FB2W Man. '94-98



Header	539 x 68	Core	
O Ring/Gasket		T/B Tank	
Condenser			
Notes			

RANGER FB4J Man. '99-03



Header	539 x 68	Core	
O Ring/Gasket		T/B Tank	
Condenser			
Notes			

RANGER FB4J Man. '99-03



Header	532 x 64	Core	
O Ring/Gasket		T/B Tank	
Condenser			
Notes			

RANGER FC3J Man. '96-02



Header	650 x 71	Core	
O Ring/Gasket		T/B Tank	
Condenser			
Notes			

RANGER FE3 Man. '91-97



Header	650 x 88	Core	
O Ring/Gasket		T/B Tank	
Condenser			
Notes			

RANGER FE / FL / FM Man. '96-00



Header	650 x 88	Core	HIN932
O Ring/Gasket		T/B Tank	HIN932BB
Condenser			
Notes	Sender Hole on Inlet Tank		

RANGER FE / FL / FM Man. '00-02



Header	650 x 88	Core	
O Ring/Gasket		T/B Tank	
Condenser			
Notes			

RANGER FE / FD Man. '10-



Header	659 x 55	Core	
O Ring/Gasket	OR659X55S	T/B Tank	
Condenser			
Notes			

RANGER FF3H Man. '90-95



Header	648 x 88	Core	HIN932
O Ring/Gasket		T/B Tank	HIN932BT/BB
Condenser			
Notes			

RANGER FG/GK Man. '99-09



Header	659 x 55	Core	HIN003
O Ring/Gasket	OR659X55S	T/B Tank	HIN003PT/PB
Condenser			
Notes			

RANGER FL / FM Man. '81-88



Header	660 x 98	Core	HIN923
O Ring/Gasket		T/B Tank	
Condenser			
Notes			

RANGER FL / FM Man. '92-96



Header	650 x 88	Core	HIN932
O Ring/Gasket		T/B Tank	HIN932BB
Condenser			
Notes	Sensor Hole on Inlet Tank		

RANGER FL1J Man. '96-00



Header	652 x 72	Core	HIN940
O Ring/Gasket		T/B Tank	
Condenser			
Notes	No Grille Side Mounts		

RANGER FM Man. '88-92



Header	652 x 109	Core	HIN997
O Ring/Gasket		T/B Tank	
Condenser			
Notes			

RANGER FM1J Man. '98-02



Header	648 x 88	Core	HIN978
O Ring/Gasket		T/B Tank	
Condenser	CHIN01		
Notes			

RANGER FM2K Man. '99-01



Header	652 x 109	Core	
O Ring/Gasket		T/B Tank	
Condenser	CHIN01		
Notes			

RANGER FM Man. '99-



Header	640 x 77	Core	
O Ring/Gasket		T/B Tank	
Condenser	CHIN01		
Notes			

RANGER FM Series Man.



Header	661 x 65	Core	
O Ring/Gasket		T/B Tank	
Condenser	CHIN01		
Notes			

RANGER FS5 Man. '03-



Header	657 x 67	Core	HIN065PA
O Ring/Gasket	OR657X67R	T/B Tank	
Condenser			
Notes			

RANGER GD Man. '96-00



Header	650 x 88	Core	HIN932
O Ring/Gasket		T/B Tank	HIN932BB
Condenser			
Notes			

RANGER GH1J Man. '00-02



Header	652 x 72	Core	HIN940
O Ring/Gasket		T/B Tank	
Condenser			
Notes	CAC Mounts on Grille Side		

RANGER KC / FD Man. '94-98



Header	656 x 67	Core	HIN001
O Ring/Gasket	OR657X67R	T/B Tank	HIN001PT/PB
Condenser			
Notes			

RANGER KC / FD Man. '94-98



Header	656 x 67	Core	HIN004
O Ring/Gasket	OR657X67R	T/B Tank	HIN001PT/PB
Condenser			
Notes			

RANGER KC / FD Man. '94-98



Header	656 x 67	Core	
O Ring/Gasket	OR657X67R	T/B Tank	
Condenser			
Notes			

RANGER KL / FE Man. '99-



Header	657 x 55	Core	HIN002
O Ring/Gasket	OR657X67R	T/B Tank	
Condenser			
Notes			

RANGER PRO Man.



Header	659 x 55	Core	HIN003
O Ring/Gasket	OR659X55S	T/B Tank	
Condenser			
Notes			

RANGER PRO GD1J Man. '03-09



Header	659 x 55	Core	
O Ring/Gasket	OR659X55S	T/B Tank	
Condenser			
Notes			

RANGER PRO 9 FG Series Man. '03-09



Header	658 x 55	Core	HIN003
O Ring/Gasket	OR659X55S	T/B Tank	HIN003PT2/PB2
Condenser			
Notes			

RANGER PRO 500 Series FM1J Man. '06-

Header	658 x 55	Core	HIN003
O Ring/Gasket	OR659X55S	T/B Tank	
Condenser			
Notes			

SUPER DOLPHIN FS Man. '94-04

Header	756 x 66	Core	HIN005
O Ring/Gasket	OR758X67R	T/B Tank	HIN005PT
Condenser			
Notes			

HITACHI

EXCAVATOR EX3600

Header	1105 x 178	Core	MDF1905
O Ring/Gasket	SP-377/C6327K	T/B Tank	
Condenser			
Notes	LT Circuit Panel		

EXCAVATOR EX3600

Header	1105 x 197	Core	MDF1906
O Ring/Gasket	E001132A/C6327K	T/B Tank	
Condenser			
Notes	HT Circuit Panel		

EXCAVATOR KX91-3

Header	367 x 54	Core	
O Ring/Gasket		T/B Tank	
Condenser			
Notes			

EXCAVATOR ZX110 / ZX120

Header	685 x 75	Core	
O Ring/Gasket		T/B Tank	
Condenser			
Notes	Isuzu Engine		

EXCAVATOR ZX200

Header		Core	
O Ring/Gasket		T/B Tank	
Condenser			
Notes			

HITACHI

EXCAVATOR ZX250 / ZX330 / ZX350



Header	Core
O Ring/Gasket	T/B Tank
Condenser	
Notes	

EXCAVATOR ZX450 / ZX470



Header	585 x 125	Core
O Ring/Gasket		T/B Tank
Condenser		
Notes		

EXCAVATOR ZAXIS 870



Header	448 x 125	Core
O Ring/Gasket		T/B Tank
Condenser		
Notes		

EXCAVATOR ZX850-3



Header	448 x 125	Core
O Ring/Gasket		T/B Tank
Condenser		
Notes		

HYSTER

HYSTER

FORKLIFT 250XM Auto.



Header	450 x 80	Core	HYS987
O Ring/Gasket		T/B Tank	
Condenser			
Notes			

FORKLIFT HS250XL Auto.



Header	468 x 80	Core	HYS930
O Ring/Gasket		T/B Tank	
Condenser			
Notes			

FORKLIFT Auto.



Header	460 x 70	Core
O Ring/Gasket		T/B Tank
Condenser		
Notes		

HYUNDAI

FORKLIFT Auto.



Header	515 x 85	Core	
O Ring/Gasket		T/B Tank	
Condenser			
Notes			

HYUNDAI

iMAX / iLOAD 2.4ltr Petrol Auto. '08-

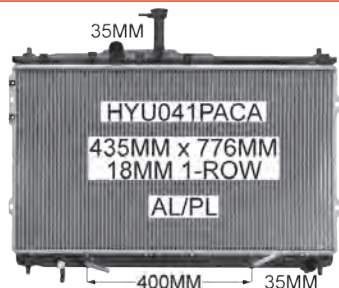

Header	783 x 46	Core	
O Ring/Gasket		T/B Tank	
Condenser	CHYU33		
Notes			

iMAX / iLOAD 2.4ltr Petrol Man. '08-

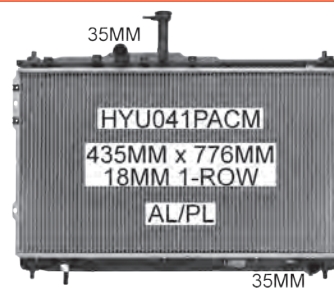

Header	783 x 46	Core	
O Ring/Gasket		T/B Tank	
Condenser	CHYU33		
Notes			

iMAX / iLOAD 2.5ltr Turbo Diesel Auto. '08-

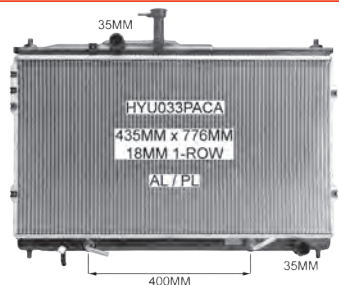

Header	783 x 46	Core	
O Ring/Gasket		T/B Tank	
Condenser	CHYU33		
Notes			

iMAX / iLOAD 2.5ltr Turbo Diesel Man. '08-

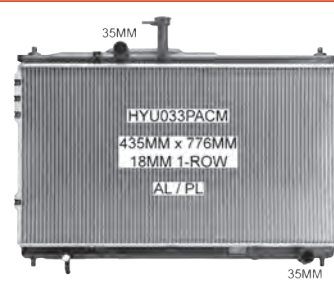

Header	783 x 46	Core	
O Ring/Gasket		T/B Tank	
Condenser	CHYU33		
Notes			

INTERNATIONAL / IVECO

ACCO 1850



Header	687 x 140	Core	SBS-1-1763
O Ring/Gasket	SBS-1763/C6327K	T/B Tank	SBS-2-1763/SBS-3-1763
Condenser			
Notes			

INTERNAT. / IVECO

ACCO 2350G

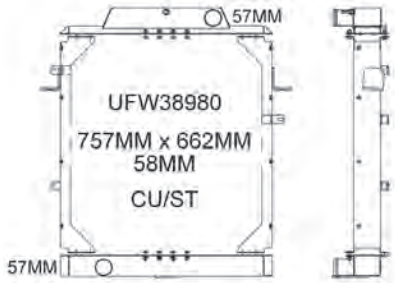

Header	730 x 148	Core	INT9192N
O Ring/Gasket	SP-5668/C6327K	T/B Tank	52892001 / 52892003
Condenser			
Notes			

DAILY Man. '97-



Header	460 x 52	Core	INT005/PA
O Ring/Gasket	OR460X55F	T/B Tank	
Condenser			
Notes			

DAILY 2.8ltr Diesel Man. '99-



Header	462 x 42	Core	
O Ring/Gasket		T/B Tank	
Condenser			
Notes	Also suit Turbo Engine		

DAILY 2.8ltr Diesel Man. '03-

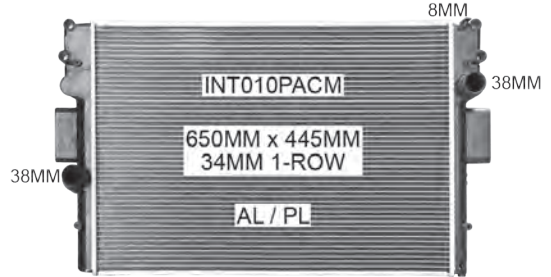

Header	457 x 54	Core	
O Ring/Gasket		T/B Tank	
Condenser	CINT01		
Notes	Also suit Turbo Engine		

DAILY 2.3ltr Turbo Diesel Auto/Man. '12-



Header		Core	
O Ring/Gasket		T/B Tank	
Condenser			
Notes			

EAGLE Man. '94-



Header	740 x 78	Core	INT8180
O Ring/Gasket		T/B Tank	INT8180BT
Condenser			
Notes			

EAGLE Man.



Header	740 x 78	Core	INT001
O Ring/Gasket	OR741X76R	T/B Tank	INT001PT
Condenser			
Notes			

EAGLE Man.



Header	748 x 84	Core	INT9180HD
O Ring/Gasket	INT9180HDGASKET	T/B Tank	
Condenser			
Notes	Ultra T Core		

EAGLE Man.

Header	703 x 84	Core	
O Ring/Gasket		T/B Tank	
Condenser			
Notes	Cat Engine		

EAGLE Man. '08-

Header	670 x 75	Core	
O Ring/Gasket		T/B Tank	
Condenser			
Notes			

EUROCARGO E18 Man. '91-

Header	600 x 60	Core	INT036PA
O Ring/Gasket		T/B Tank	
Condenser			
Notes			

EUROCARGO E18 Man. '00-

Header	600 x 60	Core	
O Ring/Gasket		T/B Tank	
Condenser	CIVE01 / 02		
Notes			

EUROCARGO E21 Man. '91-

Header	600 x 60	Core	INT036PA
O Ring/Gasket		T/B Tank	
Condenser			
Notes			

EUROCARGO E21 Man. '00-

Header	600 x 60	Core	
O Ring/Gasket		T/B Tank	
Condenser	CIVE01 / 02		
Notes			

EUROCARGO E22 Man. '01-

Header	598 x 60	Core	INT008
O Ring/Gasket		T/B Tank	
Condenser	CIVE01 / 02		
Notes			

EUROCARGO E23 Man. '91-

Header	640 x 58	Core	
O Ring/Gasket		T/B Tank	
Condenser			
Notes			

EUROCARGO E27 Man. '91-



Header	645 x 59	Core	
O Ring/Gasket		T/B Tank	
Condenser			
Notes			

EURORIDER BUS



Header		Core	
O Ring/Gasket		T/B Tank	
Condenser			
Notes			

EUROSTAR Auto. '93-



Header	732 x 88	Core	
O Ring/Gasket		T/B Tank	
Condenser			
Notes			

EUROSTAR Man. '95-

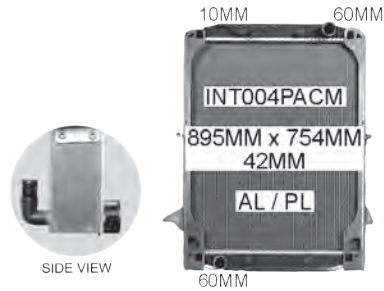

Header	769 x 70	Core	INT004
O Ring/Gasket		T/B Tank	
Condenser			
Notes	90 Degree Pipe Grille Side		

EUROSTAR Man. '95-



Header	769 x 70	Core	INT004
O Ring/Gasket		T/B Tank	
Condenser			
Notes	90 Degree Pipe Grille Side		

EUROSTAR Man. '95-



Header	769 x 70	Core	INT004
O Ring/Gasket		T/B Tank	
Condenser			
Notes			

EUROSTAR Man. '95-



Header	769 x 70	Core	INT004
O Ring/Gasket		T/B Tank	
Condenser			
Notes	90 Degree Pipe Grille Side		

EUROTECH E24 / E27 Man. '92-



Header	775 x 72	Core	
O Ring/Gasket		T/B Tank	
Condenser			
Notes			

FIRE TENDER 6V53T

Header		Core	
O Ring/Gasket		T/B Tank	
Condenser			
Notes			

POWERSTAR Man.

Header	740 x 78	Core	INT8188
O Ring/Gasket		T/B Tank	
Condenser			
Notes			

POWERSTAR Man.

Header	775 x 72	Core	
O Ring/Gasket		T/B Tank	
Condenser			
Notes	Clip On Fittings		

S LINE Man.

Header	820 x 172	Core	VHF1073
O Ring/Gasket	SP-5005	T/B Tank	
Condenser			
Notes	350HP High Flow / 3v Core		

S LINE Man.

Header	820 x 172	Core	VHF1019
O Ring/Gasket	SP-5005	T/B Tank	
Condenser			
Notes	400HP High Flow / 4v Core		

S LINE Man.

Header	820 x 172	Core	VLF1018
O Ring/Gasket	SP-5237	T/B Tank	
Condenser			
Notes	Low Flow		

S LINE Man.

Header	748 x 84	Core	INT9180HD
O Ring/Gasket	INT9180HDGASKET	T/B Tank	
Condenser			
Notes	Ultra T Core		

S3600 Man. '94-

Header	740 x 78	Core	INT001
O Ring/Gasket	OR741X76R	T/B Tank	INT001PT
Condenser			
Notes			

S3600 Man. '94-



Header	740 x 78	Core	INT8180
O Ring/Gasket		T/B Tank	INT8180BT
Condenser			
Notes			

S3600 Man. '94-



Header	748 x 84	Core	INT9180HD
O Ring/Gasket	INT9180HDGASKET	T/B Tank	
Condenser			
Notes	Ultra T Core		

SPR2 Man.



Header	775 x 72	Core	
O Ring/Gasket		T/B Tank	
Condenser			
Notes			

STRALIS Man. '02-



Header	775 x 72	Core	
O Ring/Gasket		T/B Tank	
Condenser			
Notes	Clip On Fittings		

STRALIS Man. '02-



Header	774 x 66	Core	
O Ring/Gasket		T/B Tank	
Condenser			
Notes	Clip On Fittings		

STRALIS Man. '05-



Header	775 x 72	Core	
O Ring/Gasket		T/B Tank	
Condenser			
Notes			

T LINE Man.

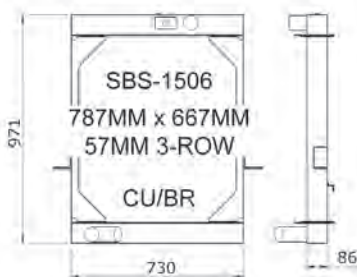

Header	730 x 140	Core	SBS-1506/3MLF11
O Ring/Gasket	SP-1286	T/B Tank	
Condenser			
Notes	250HP		

T LINE Man.

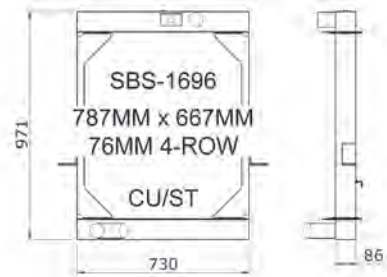

Header	730 x 140	Core	SBS-1696/4MLF12
O Ring/Gasket	SP-1286	T/B Tank	
Condenser			
Notes	Cummins LTA270		

T LINE Man.

Header	902 x 178	Core	SP-3261/3MLF11
O Ring/Gasket	SP-1470	T/B Tank	
Condenser			
Notes	350HP		

T LINE Man.

Header	918 x 186	Core	VLF1002
O Ring/Gasket	SP-1772	T/B Tank	
Condenser			
Notes	Low Flow		

INTERNATIONAL / IVECO

T LINE Man.

Header		Core	
O Ring/Gasket		T/B Tank	
Condenser			
Notes	Cummins N14 / Radiator and Cowl		

TRANSTAR Man.

Header	902 x 140	Core	VLF1000
O Ring/Gasket	SP-1290	T/B Tank	
Condenser			
Notes	Low Flow Cummins N14-444		

INTERNATIONAL / MCCORMACK

TRACTOR 564 / 574 / 595 / 674

Header	447 x 70	Core	IMC270
O Ring/Gasket		T/B Tank	
Condenser			
Notes			

INTERN. / MCCORMACK

ISEKI

COMBINE

Header	407 x 69	Core	YAN002
O Ring/Gasket		T/B Tank	
Condenser			
Notes			

ISEKI

ISUZU

FRR Auto. '03-



Header	647 x 75	Core	
O Ring/Gasket	OR648X76R	T/B Tank	
Condenser	CISU02		
Notes			

FRR Man. '96-01



Header	645 x 72	Core	ISU998
O Ring/Gasket		T/B Tank	
Condenser	CISU02		
Notes			

FRR Man. '03-06



Header	645 x 74	Core	ISU961
O Ring/Gasket		T/B Tank	
Condenser	CISU02		
Notes			

FRR Auto. '03-



Header	647 x 75	Core	
O Ring/Gasket	OR648X76R	T/B Tank	
Condenser	CISU02		
Notes			

FSR Man. '96-01



Header	645 x 72	Core	ISU998
O Ring/Gasket		T/B Tank	
Condenser	CISU02		
Notes			

FSR Man. '03-06



Header	645 x 74	Core	ISU961
O Ring/Gasket		T/B Tank	
Condenser	CISU02		
Notes			

FTR Man. '96-01



Header	645 x 72	Core	ISU998
O Ring/Gasket		T/B Tank	
Condenser	CISU02		
Notes			

FSS Man. '96-01



50MM

ISU998CM
600MM x 636MM
45MM 3-ROW
CU/BR

50MM

Header	645 x 72	Core	ISU998
O Ring/Gasket		T/B Tank	
Condenser	CISU02		
Notes			

FTS Man. '96-01



50MM

ISU998CM
600MM x 636MM
45MM 3-ROW
CU/BR

50MM

Header	645 x 72	Core	ISU998
O Ring/Gasket		T/B Tank	
Condenser	CISU02		
Notes			

FTS Man. '03-06



50MM

ISU961CM2
698MM x 635MM
60MM 4-ROW
CU/BR

50MM

Header	645 x 74	Core	ISU961
O Ring/Gasket		T/B Tank	
Condenser	CISU02		
Notes			

FVD 1000 Man. '04-



50MM

ISU009PACM
800MM x 622MM
48MM 2-ROW
AL/PL

51MM

Header	647 x 75	Core	
O Ring/Gasket	OR648X76R	T/B Tank	
Condenser	CISU02		
Notes			

FVM Man. '06-



8MM

50MM

SIDE VIEW

ISU006PACM2
650MM x 622MM
48MM 2-ROW
AL/PL

51MM (back)

51MM

51MM (back)

Header	647 X 75	Core	
O Ring/Gasket	OR648X76R	T/B Tank	
Condenser			
Notes			

FVM Man. '08-



50MM

ISU009PACM
800MM x 622MM
48MM 2-ROW
AL/PL

51MM

Header	647 x 75	Core	
O Ring/Gasket	OR648X76R	T/B Tank	
Condenser			
Notes			

FVR Man. '98-00



50MM

ISU973CM
800MM x 636MM
60MM 4-ROW
CU/BR

50MM

Header	645 x 74	Core	ISU973
O Ring/Gasket		T/B Tank	ISU973BT/BB
Condenser			
Notes	Non Turbo Engine		

FVR Man. '06-



8MM

50MM

SIDE VIEW

ISU006PACM2
650MM x 622MM
48MM 2-ROW
AL/PL

51MM (back)

51MM

51MM (back)

Header	647 X 75	Core	
O Ring/Gasket	OR648X76R	T/B Tank	
Condenser			
Notes			

FVR Man. '08-



Header	647 x 75	Core	
O Ring/Gasket	OR648X76R	T/B Tank	
Condenser			
Notes			

FVZ / FVY1400 Man.



Header	647 x 75	Core	
O Ring/Gasket	OR648X76R	T/B Tank	
Condenser			
Notes			

FXR 1000 Man. '08-



Header	731 x 75	Core	
O Ring/Gasket		T/B Tank	
Condenser			
Notes			

FXZ 1500 Man. '08-11



Header	731 x 75	Core	
O Ring/Gasket		T/B Tank	
Condenser			
Notes			

GIGA CXZ51 Man. '00-09



Header	731 x 75	Core	
O Ring/Gasket		T/B Tank	
Condenser			
Notes	6WF1 & 6WG1 Engines		

GIGA CXZ52 Man. '98-



Header	731 x 75	Core	
O Ring/Gasket		T/B Tank	
Condenser			
Notes	6WF1 & 6WG1 Engines		

GIGA CXY385 Series Man. '06-



Header	731 x 75	Core	
O Ring/Gasket		T/B Tank	
Condenser			
Notes			

GIGA CYJ330 Man.



Header	731 x 75	Core	
O Ring/Gasket		T/B Tank	
Condenser			
Notes			

GIGA E Series Man. '00-

Header	731 x 75	Core	
O Ring/Gasket		T/B Tank	
Condenser			
Notes			

GIGA EXD52 Man. '06-09

Header	731x 75	Core	
O Ring/Gasket		T/B Tank	
Condenser			
Notes	6WF1 & 6WG1 Engines		

GIGA EXD52 Man. '06-09

Header	731 x 75	Core	
O Ring/Gasket		T/B Tank	
Condenser			
Notes			

GIGA FXD455 Man.

Header	731 x 75	Core	
O Ring/Gasket		T/B Tank	
Condenser			
Notes			

JCR Man.

Header	528 x 84	Core	ISU917
O Ring/Gasket		T/B Tank	ISU917BT/BB
Condenser			
Notes			

NKR 66 Man. '90-02

Header	492 x 50	Core	ISU099PA
O Ring/Gasket	OR493X52R	T/B Tank	ISU099PT/PB
Condenser			
Notes			

NLR Auto. '02-

Header	492 x 52	Core	
O Ring/Gasket	OR493X52R	T/B Tank	
Condenser			
Notes			

NLR Man. '02-

Header	492 x 52	Core	
O Ring/Gasket	OR493X52R	T/B Tank	
Condenser			
Notes			

NPR Auto. '99-



Header	492 x 50	Core	ISU099PA
O Ring/Gasket	OR493X52R	T/B Tank	ISU099PT/PB
Condenser			
Notes	4HG1 Engine		

NPR 71 Man. '94-03



Header	492 x 50	Core	ISU099PA
O Ring/Gasket	OR493X52R	T/B Tank	ISU099PT/PB
Condenser			
Notes			

NPR Man. '99-



Header	570 x 52	Core	ISU001
O Ring/Gasket	OR570X52R	T/B Tank	ISU001PT/PB
Condenser			
Notes			

NPR 300 Auto. '03-07



Header	570 x 57	Core	ISU092PA
O Ring/Gasket		T/B Tank	
Condenser	CISU02		
Notes	Sensor Hole on Grille Side		

NPR 300 Man. '03-07



Header	570 x 57	Core	ISU092PA
O Ring/Gasket		T/B Tank	
Condenser	CISU02		
Notes	Sensor Hole on Grille Side		

NPR 300 Auto. '04-



Header	614 x 52/57	Core	ISU004PA
O Ring/Gasket	OR614X52R/OR616X55R	T/B Tank	ISU004PT/PB
Condenser	CISU02		
Notes			

NPR 300 Man. '04-



Header	614 x 52/57	Core	ISU004PA
O Ring/Gasket	OR614X52R/OR616X55R	T/B Tank	ISU004PT/PB
Condenser	CISU02		
Notes			

NPR 300 Man. '05-

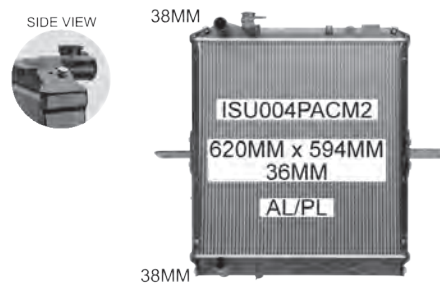

Header	614 x 52/57	Core	ISU004PA
O Ring/Gasket	OR614X52R/OR616X55R	T/B Tank	
Condenser	CISU02		
Notes	NPR75		

NPS 300 Turbo Man. '07-

Header	569 x 52	Core	ISU002/PA
O Ring/Gasket		T/B Tank	
Condenser			
Notes	Top Mounts Located on Grille Side		

NPS Man.

Header	569 x 52	Core	ISU002/PA
O Ring/Gasket		T/B Tank	
Condenser			
Notes	Top Mounts Located on Grille Side		

NQR 300 Auto. '03-07

Header	570 x 57	Core	ISU092PA
O Ring/Gasket		T/B Tank	
Condenser			
Notes	Sensor Hole on Grille Side		

NQR 300 Man. '03-07

Header	570 x 57	Core	ISU092PA
O Ring/Gasket		T/B Tank	
Condenser			
Notes	Sensor Hole on Grille Side		

NQR 300 Auto. '04-

Header	614 x 52/57	Core	ISU004PA
O Ring/Gasket	OR614X52R/OR616X55R	T/B Tank	ISU004PT/PB
Condenser			
Notes			

NQR 300 Man. '04-

Header	614 x 52/57	Core	ISU004PA
O Ring/Gasket	OR614X52R/OR616X55R	T/B Tank	ISU004PT/PB
Condenser			
Notes			

NQR 450 Auto. '05-10

Header	614 x 52/57	Core	ISU004PA
O Ring/Gasket	OR614X52R/OR616X55R	T/B Tank	ISU004PT/PB
Condenser			
Notes			

NQR 450 Man. '05-10

Header	614 x 52/57	Core	ISU004PA
O Ring/Gasket	OR614X52R/OR616X55R	T/B Tank	ISU004PT/PB
Condenser			
Notes			

ISUZU

N SERIES Diesel Man. '00-



Header	492 x 50	Core	ISU099PA
O Ring/Gasket	OR493X52R	T/B Tank	ISU099PB
Condenser			
Notes			

N SERIES Diesel Man. '03-



Header	492 x 50	Core	ISU099PA
O Ring/Gasket	OR493X52R	T/B Tank	ISU099PB
Condenser			
Notes			

N SERIES Man. '08-



Header	569 x 52	Core	ISU002/PA
O Ring/Gasket		T/B Tank	
Condenser			
Notes	Mounts located on grille side of Inlet tank		

Header		Core	
O Ring/Gasket		T/B Tank	
Condenser			
Notes			

JCB

JCB

EXCAVATOR



Header	625 x 130	Core	
O Ring/Gasket		T/B Tank	
Condenser			
Notes			

FORKLIFT '06-



Header	528 x 95	Core	
O Ring/Gasket		T/B Tank	
Condenser			
Notes			

ROLLER

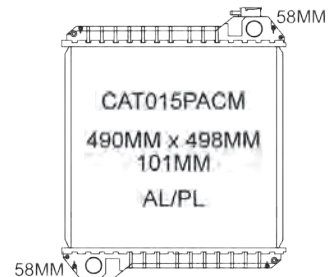

Header		Core	
O Ring/Gasket		T/B Tank	
Condenser			
Notes			

JOHN DEERE

TRACTOR 2030/2130



Header	355 x 80	Core	
O Ring/Gasket		T/B Tank	
Condenser			
Notes			

TRACTOR 2955/3050/3155/3350/3650

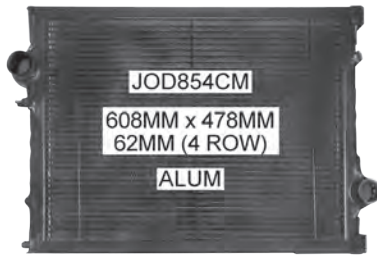

Header		Core	
O Ring/Gasket		T/B Tank	
Condenser			
Notes			

TRACTOR 4348



Header		Core	
O Ring/Gasket		T/B Tank	
Condenser			
Notes			

TRACTOR 6320/6420/6520/6620



Header		Core	
O Ring/Gasket		T/B Tank	
Condenser			
Notes			

TRACTOR 6120/6220/6320/6420/6515/6520/6620/6820/6920



Header		Core	
O Ring/Gasket		T/B Tank	
Condenser			
Notes			

TRACTOR 6100/6200/6300/6500/6506/6800 '93-



Header	520 x 93	Core	JOD002
O Ring/Gasket		T/B Tank	
Condenser			
Notes			

TRACTOR 6100/6600/6800 '93-



Header	522 x 93	Core	JOD004
O Ring/Gasket		T/B Tank	
Condenser			
Notes			

JOHN DEERE

TRACTOR 6200/6300/6400/6500/6506/6800 '93-



Header	520 x 93	Core	JOD002
O Ring/Gasket		T/B Tank	
Condenser			
Notes			

TRACTOR 6130/6230/6330/6430 '09-



Header		Core	
O Ring/Gasket		T/B Tank	
Condenser			
Notes			

TRACTOR 6530/6534/6630/6830/6930 '09-

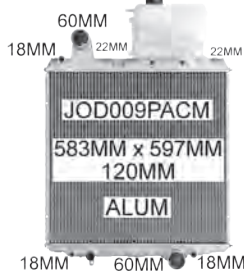

Header		Core	
O Ring/Gasket		T/B Tank	
Condenser			
Notes			

TRACTOR 7425/7525



Header		Core	
O Ring/Gasket		T/B Tank	
Condenser			
Notes			

KENWORTH

KENWORTH

1200 Square Inch

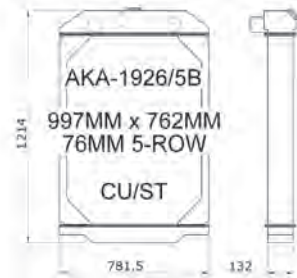

Header	816 x 186	Core	MLF1027
O Ring/Gasket	SP-839	T/B Tank	AKA-2-1926B / AKA-3-1926
Condenser			
Notes	400HP / Request Left or Right		

1200 Square Inch

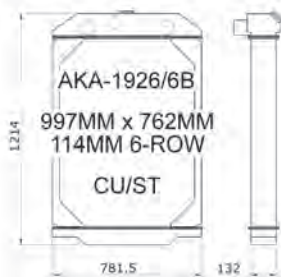

Header	816 x 186	Core	MLF1038
O Ring/Gasket	SP-839	T/B Tank	AKA-2-1926B / AKA-3-1926
Condenser			
Notes	Heavy Duty / Request Left or Right		

1360 Sq In Heavy Duty

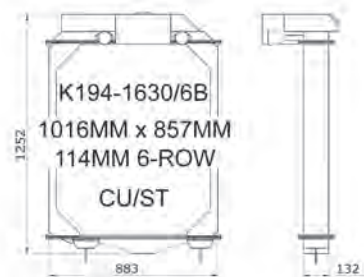

Header	918 x 186	Core	MLF1039
O Ring/Gasket	SP-1772	T/B Tank	T9000335
Condenser			
Notes			

1360 Sq In to 400HP

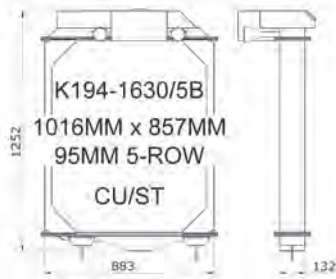

Header	918 x 186	Core	MLF1451
O Ring/Gasket	SP-1772	T/B Tank	T9000335
Condenser			
Notes			

1400 Square Inch W Model

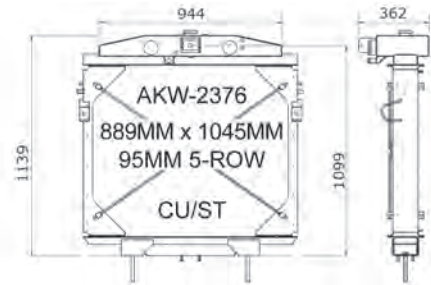

Header	1105 x 186	Core	MLF1032
O Ring/Gasket	SP-1992	T/B Tank	K194-2-1751-B / K194-1673
Condenser			
Notes	Up to 425HP		

C500

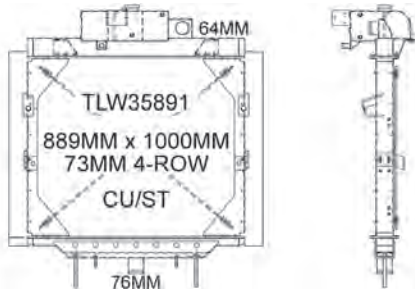

Header	1073 x 140	Core	MLF1558
O Ring/Gasket	SP-2506	T/B Tank	T220229A / T220113A
Condenser			
Notes	Caterpillar C15 Engine		

C500

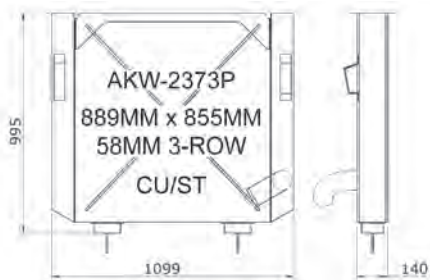

Image Not Currently Available

TLW33032

Header	1073 x 140	Core	MLF1558
O Ring/Gasket	SP-2506	T/B Tank	T220224A / T220023A
Condenser			
Notes	Caterpillar C15 Engine		

C500



Header	945 x 140	Core	VHF1007
O Ring/Gasket	SP-2503	T/B Tank	
Condenser			
Notes	High Flow		

C500



Image Not Currently Available

AKW-2373

Header	945 x 140	Core	VHF1007
O Ring/Gasket	SP-2503	T/B Tank	
Condenser			
Notes	High Flow / Includes Expansion Tank		

C500

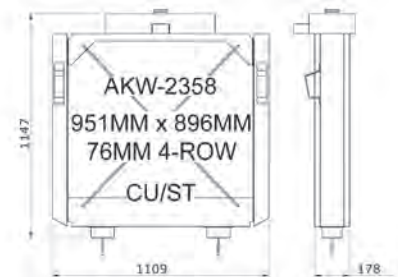

Image Not Currently Available

AKW-2358P

Header	987 x 178	Core	VLF1008
O Ring/Gasket	SP-2512	T/B Tank	
Condenser			
Notes	Low Flow		

C500



Header	987 x 178	Core	VLF1008
O Ring/Gasket	SP-2512	T/B Tank	
Condenser			
Notes	Low Flow / Includes Expansion Tank		

C508

Header	1159 x 178	Core	MLF2024
O Ring/Gasket	SP-2516	T/B Tank	T220427A / T220428A
Condenser			
Notes	Caterpillar C15 Engine		

C509

Header	1159 x 178	Core	MLF2024
O Ring/Gasket	SP-2516	T/B Tank	T221004A / T220820A
Condenser			
Notes	2 Pass		

C510

Header		Core	
O Ring/Gasket		T/B Tank	
Condenser			
Notes	Cummins QSK19		

C510

Header	1159 x 178	Core	MLF1543
O Ring/Gasket	SP-2516	T/B Tank	12428001 / 14092003
Condenser			
Notes	Cummins QSK19		

C510 / C540

Header	1159 x 178	Core	MLF1543
O Ring/Gasket	SP-2516	T/B Tank	12428001 / 12428002
Condenser			
Notes	Cummins QSK19 / Part A / Part B also required		

C510 / C540

Header	1159 x 140	Core	MLF1544
O Ring/Gasket	SP-2508	T/B Tank	12429001 / 12429002
Condenser			
Notes	Cummins QSK19 / Part B / Part A also required		

T400

Header	816 x 186	Core	VLF1009
O Ring/Gasket	SP-4999	T/B Tank	X-3603-1 / T100025A
Condenser			
Notes	Low Flow		

T440 / T480

Header	859 x 140	Core	MLF1082
O Ring/Gasket	SP-1289	T/B Tank	T210055A / T210056A
Condenser			
Notes	Crossflow Radiator / CAT3176/ CUMMINS M11 Engine		

T440 / T480

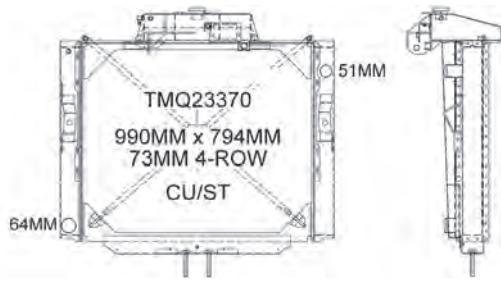

Header	859 x 140	Core	MLF1554
O Ring/Gasket	SP-1289	T/B Tank	T210055A / T210056A
Condenser			
Notes	Crossflow Radiator / CAT3176/ CUMMINS M11 Engine		

K100

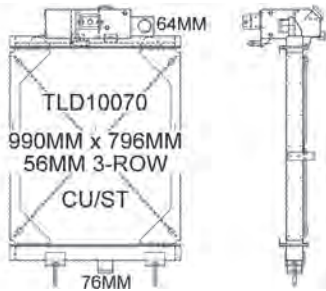

Image Not Currently Available

AKW-2357

Header	918 x 186	Core	VLF1002
O Ring/Gasket	SP-1772	T/B Tank	K194-2-1782 / K194-3-1782
Condenser			
Notes	Cummins L10 / N14 Engines		

K100E



Header	859 x 140	Core	VHF1005
O Ring/Gasket	SP-1289	T/B Tank	T200033A / T200018A
Condenser			
Notes			

K100E

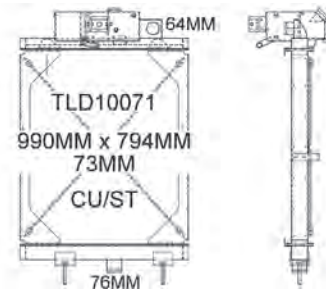

Header	859 x 140	Core	MLF1082
O Ring/Gasket	SP-1289	T/B Tank	T200033A / T200018A
Condenser			
Notes			

K100E

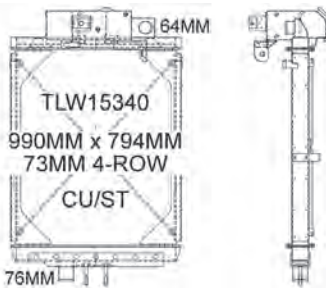

Header	859 x 140	Core	MLF1082
O Ring/Gasket	SP-1289	T/B Tank	T200119A / T200120A
Condenser			
Notes	Cummins N14/Detroit Series 60/CAT3406B Engines		

K100G

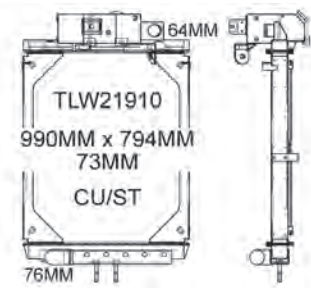

Header	859 x 140	Core	MLF1082
O Ring/Gasket	SP-1289	T/B Tank	T200119A / T200128A
Condenser			
Notes			

K100G

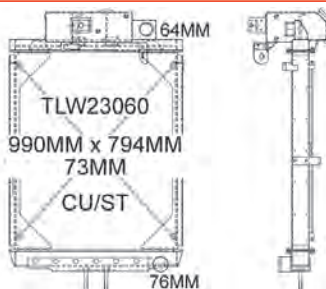

Header	859 x 140	Core	MLF1082
O Ring/Gasket	SP-1289	T/B Tank	T200119A / T200179A
Condenser			
Notes			

K104



Image Not Currently Available

TLW33020

Header	859 x 140	Core	MLF1554
O Ring/Gasket	SP-1289	T/B Tank	T200210A / T200179A
Condenser			
Notes	Cummins Engine		

K104G





Image Not Currently Available

TLW33010

Header	859 x 140	Core	MLF1554
O Ring/Gasket	SP-1289	T/B Tank	T200209A / T200179A
Condenser			
Notes	Caterpillar C15 & C16/Detroit 60 Series Engines		

K108



TLW52350
1125MM x 794MM
73MM
CU/ST

Header	859 x 140	Core	MLF1948
O Ring/Gasket	SP-1289	T/B Tank	T220551A / T220323A
Condenser			
Notes			

K108

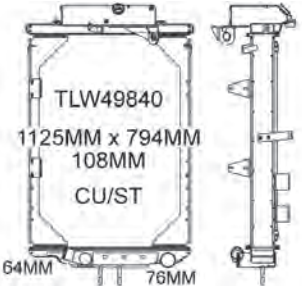

TLW49840
1125MM x 794MM
108MM
CU/ST
64MM 76MM

Header	859 x 178	Core	MLF1944
O Ring/Gasket	SP-1469	T/B Tank	T220270A / T220271A
Condenser			
Notes			

K108



TLW43890
1125MM x 794MM
73MM
CU/ST

Header	859 x 140	Core	MLF1948
O Ring/Gasket	SP-1288	T/B Tank	T220315A / T220323A
Condenser			
Notes	ISX EGR		

K108

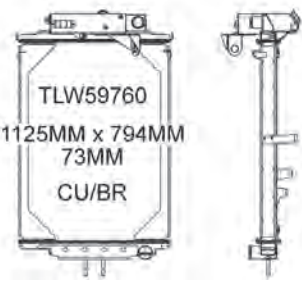

TLW59760
1125MM x 794MM
73MM
CU/BR

Header	859 x 140	Core	MLF1948
O Ring/Gasket	SP-1288	T/B Tank	T220746A / T220323A
Condenser			
Notes	ISX EGR 4 Row		

K108

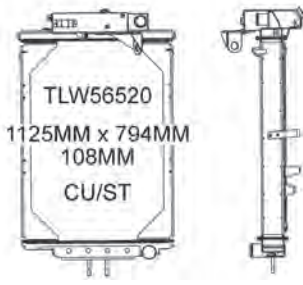

TLW56520
1125MM x 794MM
108MM
CU/ST

Header	859 x 178	Core	MLF2177
O Ring/Gasket	SP-1469	T/B Tank	T220661A / T220617A
Condenser			
Notes	ISX EGR Single Pass		

K200



TLW62890
1125MM x 794MM
108MM
CU/BR
64MM 64MM

Header	859 x 178	Core	MLF2107
O Ring/Gasket	SP-1469	T/B Tank	
Condenser			
Notes			

T350





Image Not Currently Available

TMW40170

Header	859 x 140	Core	MLF1492/K
O Ring/Gasket	SP-1289	T/B Tank	T210095A / T210097A
Condenser			
Notes			

T358

Header	859 x 140	Core	MLF1554/K
O Ring/Gasket	SP-1289	T/B Tank	T210104A / T210097A
Condenser			
Notes			

T401

Image Not Currently Available

TMW34971

Header	859 x 140	Core	MLF1082
O Ring/Gasket	SP-1289	T/B Tank	T210095A / T210097A
Condenser			
Notes			

T402

Header	987 x 140	Core	MLF2081
O Ring/Gasket	SP-2504	T/B Tank	T220600A / T220599A
Condenser			
Notes			

T404

Image Not Currently Available

TLW38651

Header	859 x 140	Core	MLF1554
O Ring/Gasket	SP-1289	T/B Tank	T200217A / T200230B
Condenser			
Notes			

T404 / T404S

Header	859 x 140	Core	MLF1554
O Ring/Gasket	SP-1289	T/B Tank	T200217A / T200196A
Condenser			
Notes			

T404 / T404S

Header	859 x 140	Core	MLF1554
O Ring/Gasket	SP-1289	T/B Tank	T200208A / T200196A
Condenser			
Notes			

T408

Header	1159 x 140	Core	MLF2009
O Ring/Gasket	SP-2508	T/B Tank	T220425A / T220408A
Condenser			
Notes	SAR Cummins ISX Engine		

T408

Header	1159 x 140	Core	MLF2009
O Ring/Gasket	SP-2508	T/B Tank	T220565A / T220389A
Condenser			
Notes			

T408

Header	1159 x 140	Core	MLF2009
O Ring/Gasket	SP-2508	T/B Tank	T220483A / T220484A
Condenser			
Notes	CAT C13 Acert Engine		

T408 / T409

Header	1159 x 140	Core	MLF2009
O Ring/Gasket	SP-2508	T/B Tank	T220567A / T220408A
Condenser			
Notes	SAR Cummins ISX Engine		

T604 / T650

Header	902 x 140	Core	MLF1557
O Ring/Gasket	SP-1290	T/B Tank	T220155A / T220156A
Condenser			
Notes	CAT C15/C16 Engines		

T608 / T650II / T659 / T659

Header	1159 x 140	Core	MLF1900
O Ring/Gasket	SP-2508	T/B Tank	T220880A / T220416A
Condenser			
Notes	Cummins ISX Engine		

T900

Header	859 x 140	Core	VHF1005
O Ring/Gasket	SP-1289	T/B Tank	T200006A / T200005A
Condenser			
Notes	Cummins N14 Engine		

T900 / T950

Header	1073 x 140	Core	VHF1512
O Ring/Gasket	SP-2506	T/B Tank	T220022A / T220023A
Condenser			
Notes	CAT3406E Engine		

T904

Image Not Currently Available

TLW33030

Header	1073 x 140	Core	MLF1558
O Ring/Gasket	SP-2506	T/B Tank	T220224A / T220023A
Condenser			
Notes	CAT / Detroit Engines		

T904

Header	1073 x 140	Core	MLF1558
O Ring/Gasket	SP-2506	T/B Tank	T220224A / T220023A
Condenser			
Notes	CAT / Detroit Engines		

T904 / T908

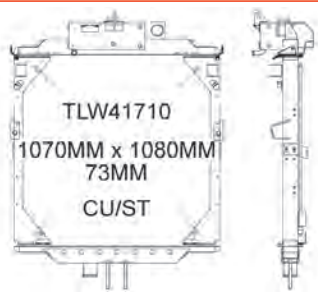

Header	1159 x 140	Core	MLF1900
O Ring/Gasket	SP-2508	T/B Tank	T220237A / T220238A
Condenser			
Notes	CAT C15/C16 Engines		

T908

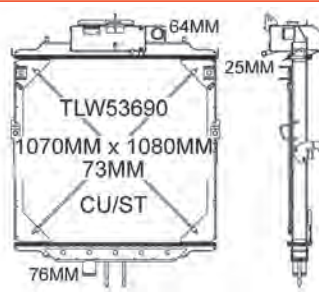

Header	1159 x 140	Core	MLF1900
O Ring/Gasket	SP-2508	T/B Tank	T220576A / T220577A
Condenser			
Notes			

KENWORTH

KIA

K2700 2.7ltr Diesel Man. '02-05



Header	648 x 47	Core	
O Ring/Gasket		T/B Tank	
Condenser			
Notes			

KIA

K2900 Man. '08-





Header	586 x 61	Core	
O Ring/Gasket		T/B Tank	
Condenser	CKIA29		
Notes			

Header		Core	
O Ring/Gasket		T/B Tank	
Condenser			
Notes			

KOMATSU

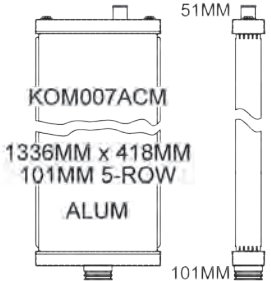
DOZER D375A



Header		Core	
O Ring/Gasket		T/B Tank	
Condenser			
Notes			

KOMATSU

KOMATSU

DOZER D65EX-16

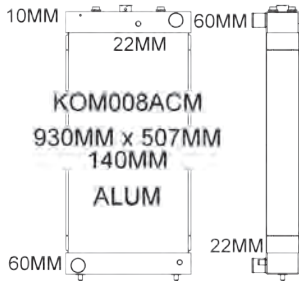

Header	Core
O Ring/Gasket	T/B Tank
Condenser	
Notes	

DUMP TRUCK HD465-7 / HD605



Header	Core
O Ring/Gasket	T/B Tank
Condenser	
Notes	

EXCAVATOR



Header	749 x 85	Core	KOM001
O Ring/Gasket		T/B Tank	
Condenser			
Notes	CAT 320B Engine		

EXCAVATOR PC40 / PC45



Header	407 x 69	Core	
O Ring/Gasket		T/B Tank	
Condenser			
Notes			

EXCAVATOR PC40R-8 / PC45R-8



Header	426 x 40/50	Core	KOM003
O Ring/Gasket		T/B Tank	
Condenser			
Notes			

EXCAVATOR PC200-7



Header		Core	
O Ring/Gasket		T/B Tank	
Condenser			
Notes			

EXCAVATOR PC228



Header	749 x 85	Core	KOM001
O Ring/Gasket		T/B Tank	
Condenser			
Notes			

EXCAVATOR PC270



Header	328 x 125	Core	
O Ring/Gasket		T/B Tank	
Condenser			
Notes			

EXCAVATOR PC300-8

Header	446 x 115	Core	
O Ring/Gasket		T/B Tank	
Condenser			
Notes			

EXCAVATOR PC450LC-7 / PC400-7

Header	446 x 115	Core	
O Ring/Gasket		T/B Tank	
Condenser			
Notes			

FORKLIFT Petrol Auto. '95-

Header	446 x 85	Core	TOY014
O Ring/Gasket	OR446X85R	T/B Tank	
Condenser			
Notes			

FORKLIFT Petrol Auto. '95-

Header	446 x 85 10mm FOH	Core	TOY014
O Ring/Gasket		T/B Tank	
Condenser			
Notes			

FORKLIFT Auto.

Image Not Currently Available

TOY152PACA3

Header	446 x 85	Core	TOY152
O Ring/Gasket	OR446X85R	T/B Tank	
Condenser			
Notes			

LOADER WA380-5H

Header		Core	
O Ring/Gasket		T/B Tank	
Condenser			
Notes			

LOADER WA-500-6

Header		Core	
O Ring/Gasket		T/B Tank	
Condenser			
Notes	Left Module		

LOADER WA-500-6

Header		Core	
O Ring/Gasket		T/B Tank	
Condenser			
Notes	Right Module		

KOMATSU

WHEEL LOADER WA470-6 / WA450-6 / WA480-6



Header	446 x 115	Core	
O Ring/Gasket		T/B Tank	
Condenser			
Notes	Left Module		

WHEEL LOADER WA470-6 / WA450-6 / WA480-6



Header	446 x 115	Core	
O Ring/Gasket		T/B Tank	
Condenser			
Notes	Right Module		

KUBOTA

KUBOTA

MIN EXCAVATOR

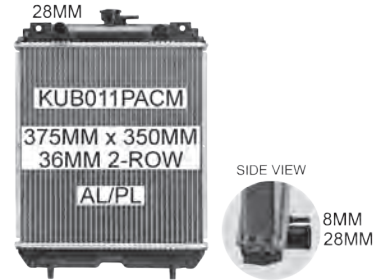

Header	367 x 54	Core	
O Ring/Gasket		T/B Tank	
Condenser			
Notes			

MOWER



Header	407 x 69	Core	KUB006
O Ring/Gasket		T/B Tank	
Condenser			
Notes			

MOWER F3060



Header	407 x 69	Core	KUB066PA
O Ring/Gasket		T/B Tank	
Condenser			
Notes			

TRACTOR



Header	407 x 69	Core	KUB006
O Ring/Gasket		T/B Tank	
Condenser			
Notes			

Header		Core	
O Ring/Gasket		T/B Tank	
Condenser			
Notes			

LINDE

COMBICOOLER Module

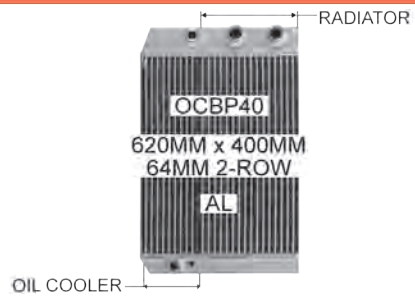

Header		Core	
O Ring/Gasket		T/B Tank	
Condenser			
Notes	Bar & Plate / Radiator & Oil Cooler Module		

MACK

CH Man. '92-



Header	1023 x 83	Core	MAC003
O Ring/Gasket	OR1023X83R	T/B Tank	MAC003PT/PB
Condenser	CMAC05		
Notes			

CH Man.



Header	1023 x 70	Core	MAC840
O Ring/Gasket		T/B Tank	MAC840BT/BB
Condenser	CMAC05		
Notes			

GRANITE Auto.

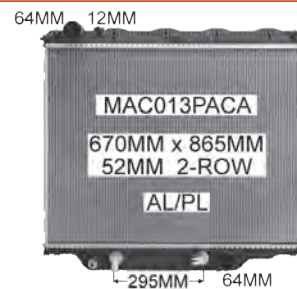

Header	890 x 70	Core	
O Ring/Gasket	OR893X72R	T/B Tank	MAC012PT/PBA
Condenser			
Notes			

GRANITE Auto.



Header	890 x 70	Core	
O Ring/Gasket	OR893X72R	T/B Tank	MAC012PT/PBA
Condenser			
Notes			

GRANITE Auto. '09-



Header	890 x 70	Core	
O Ring/Gasket	OR893X72R	T/B Tank	MAC012PT/PBA
Condenser			
Notes			

MACK

MAGNUM Man.



Header	1023 x 70	Core	MAC840
O Ring/Gasket		T/B Tank	MAC840BT/BB
Condenser			
Notes			

METROLINER Auto.

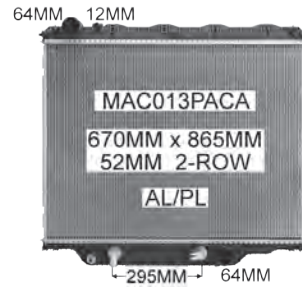

Header	890 x 70	Core	
O Ring/Gasket	OR893X72R	T/B Tank	MAC012PT/PBA
Condenser			
Notes			

METROLINER Man.



Image Not Currently Available

MAC008PACM

Header		Core	
O Ring/Gasket		T/B Tank	
Condenser			
Notes	May also suit Volvo Truck		

MIDLUM Man. '01-



Header	596 x 72	Core	
O Ring/Gasket		T/B Tank	
Condenser			
Notes			

PREMIUM Man. '02-



Header	740 x 73	Core	
O Ring/Gasket		T/B Tank	
Condenser			
Notes	Angled Inlet Pipe		

PREMIUM Man. '00-



Header	740 x 73	Core	
O Ring/Gasket		T/B Tank	
Condenser			
Notes	Straight Inlet Pipe		

PREMIUM Man. '02-



Header	740 x 73	Core	
O Ring/Gasket		T/B Tank	
Condenser			
Notes			

QUANTUM Man.

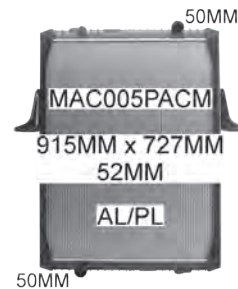

Header	748 x 71	Core	MAC005
O Ring/Gasket		T/B Tank	
Condenser			
Notes	Straight Inlet Pipe		

QUANTUM Man.



Header	748 x 71	Core	MAC005
O Ring/Gasket		T/B Tank	
Condenser			
Notes	Angled Inlet Pipe		

SUPERLINER Auto.



Header	890 x 70	Core	
O Ring/Gasket	OR893X72R	T/B Tank	MAC012PT/PBA
Condenser			
Notes			

TRIDENT Auto. '08-



Header	890 x 53	Core	
O Ring/Gasket	OR893X72R	T/B Tank	MAC012PT/PBA
Condenser	CMAC05		
Notes			

TRIDENT Auto.



Header	890 x 69	Core	
O Ring/Gasket	OR893X72R	T/B Tank	MAC012PT
Condenser	CMAC05		
Notes			

VISION Auto.



Header	890 x 69	Core	
O Ring/Gasket	OR893X72R	T/B Tank	MAC012PT
Condenser	CMAC04		
Notes			

VISION Man. '03-



Header	748 x 71	Core	MAC005
O Ring/Gasket		T/B Tank	
Condenser	CMAC04		
Notes	Straight Inlet Pipe		

VISION Man. '03-



Header	748 x 71	Core	MAC005
O Ring/Gasket		T/B Tank	
Condenser	CMAC04		
Notes	Angled Inlet Pipe		

Header		Core	
O Ring/Gasket		T/B Tank	
Condenser			
Notes			

MAN

BUS UL 313 / 353 Man. '96-



Header	732 x 72	Core	MAN004
O Ring/Gasket		T/B Tank	
Condenser			
Notes			BEHR MELLER SERVICE

BUS CITY A20/A35/A66/A69/A91 Man.



Header	730 x 71	Core	
O Ring/Gasket		T/B Tank	
Condenser			
Notes			ADRAD RADIATORS

F2000 Man. '94-



Header	732 x 72	Core	MAN004
O Ring/Gasket		T/B Tank	
Condenser			
Notes			ADRAD RADIATORS

L2000 8.103-10.163 Man. '93-



Header	644 x 77	Core	MAN002/PA
O Ring/Gasket		T/B Tank	
Condenser			
Notes			ADRAD RADIATORS

L2000 Man. '93-97



Header	644 x 77	Core	MAN006/PA
O Ring/Gasket		T/B Tank	
Condenser			
Notes			ADRAD RADIATORS

LE Man.



Header	644 x 77	Core	MAN002/PA
O Ring/Gasket		T/B Tank	
Condenser			
Notes			ADRAD RADIATORS

TGA 26.410 / 26.460 Man '00-



Header	960 x 70	Core	
O Ring/Gasket		T/B Tank	
Condenser			
Notes			BEHR MELLER SERVICE

TGA Man. '00-



Header	Core	
O Ring/Gasket	T/B Tank	
Condenser		
Notes	Suits Various Models	

TGL Man. '08-



Header	644 x 77	Core	
O Ring/Gasket		T/B Tank	
Condenser			
Notes	22mm Fitting is Clip On		

TGM Man. '05-



Header	644 x 77	Core	
O Ring/Gasket		T/B Tank	
Condenser			
Notes			

TGM Man. '08-



Header	644 x 77	Core	
O Ring/Gasket		T/B Tank	
Condenser			
Notes	22mm Fitting is Clip On		

MANITOWOC

GROVE CRANE GMK5100



Header	841 x 77	Core	MER029
O Ring/Gasket	OR841X77R	T/B Tank	MER029PT/PB
Condenser			
Notes			

MAZDA

T3000 Man. '80-



Header	502 x 49	Core	MAZ964
O Ring/Gasket		T/B Tank	
Condenser			
Notes			

MAN

MANITOWOC

MAZDA

MAZDA

T3500 Man. '80-



Header	502 x 49	Core	MAZ964
O Ring/Gasket		T/B Tank	
Condenser			
Notes			

T4000 Man. '99-



Header	504 x 52	Core	MAZ029
O Ring/Gasket		T/B Tank	
Condenser			
Notes			

T4600 Man. '00-



Header	504 x 52	Core	
O Ring/Gasket		T/B Tank	
Condenser			
Notes			

Header		Core	
O Ring/Gasket		T/B Tank	
Condenser			
Notes			

MERCEDES BENZ

MERCEDES BENZ

ACTROS Auto. '96-



Header	842 x 79	Core	
O Ring/Gasket		T/B Tank	
Condenser	CMER63		
Notes			

ACTROS OM542 Auto. '96-



Header	841 x 77	Core	MER029
O Ring/Gasket	OR841X77R	T/B Tank	MER029PT/PB
Condenser	CMER63		
Notes			

ATEGO 815 Man. '98-



Header	548 x 62	Core	MER055
O Ring/Gasket	OR550X62R	T/B Tank	MER055PT/PB
Condenser			
Notes	OM 906 Engine		

ATEGO 917 Man. '98-

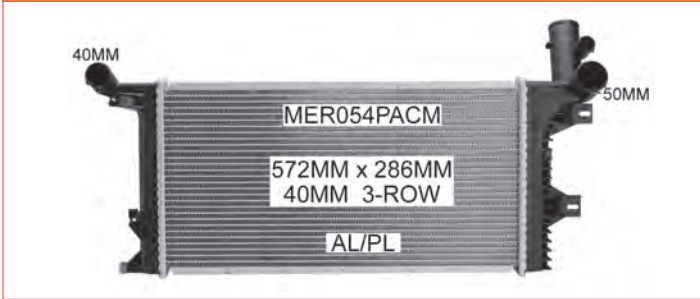

Header	319 x 62	Core	MER054
O Ring/Gasket	OR320X62R	T/B Tank	MER054PT/PB
Condenser			
Notes	OM 904 MotoEuro II Engine		

AXOR Man. '02-



Header	701 x 78	Core	
O Ring/Gasket		T/B Tank	
Condenser			
Notes			

AXOR 1833 Auto. '05-



Header	700 x 76	Core	
O Ring/Gasket		T/B Tank	
Condenser			
Notes			

BUS 507 Diesel Man. '86-



Header	406 x 65	Core	
O Ring/Gasket	OR407X46R	T/B Tank	
Condenser			
Notes			

BUS EVO O580/O500LE/OC500L Man. '99-

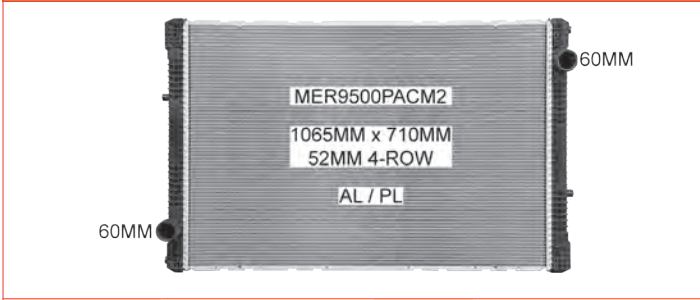

Header	724 x 76	Core	MER9500
O Ring/Gasket		T/B Tank	
Condenser			
Notes	Without Frame		

BUS EVO O580/O500LE/OC500L Man. '99-



Header	724 x 76	Core	MER9500
O Ring/Gasket		T/B Tank	
Condenser			
Notes	With Frame		

BUS O404 Auto.



Header	732 x 88	Core	
O Ring/Gasket		T/B Tank	
Condenser			
Notes			

BUS O580-17 Man. '99-



Header		Core	
O Ring/Gasket		T/B Tank	
Condenser			
Notes			

MERCEDES BENZ

BUS TRAVEGO



Header	Core
O Ring/Gasket	T/B Tank
Condenser	
Notes	BEHR KELLER SERVICE

SPRINTER VAN 2.3ltr/2.9ltr Auto. '98-5/00



Header	435 x 60	Core	MER096PA
O Ring/Gasket		T/B Tank	
Condenser	CMER55		
Notes			ADRAD RADIATORS

SPRINTER VAN 2.3ltr/2.9ltr Man. '98-5/00

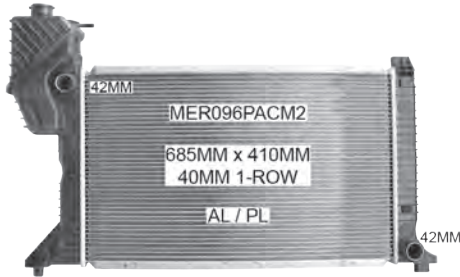

Header	435 x 60	Core	MER096PA
O Ring/Gasket		T/B Tank	
Condenser	CMER55		
Notes			ADRAD RADIATORS

SPRINTER VAN Auto. '6/00-06

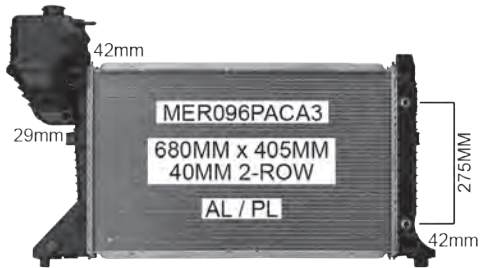

Header	435 x 60	Core	MER096PA
O Ring/Gasket		T/B Tank	
Condenser			
Notes			ADRAD RADIATORS

SPRINTER VAN Man. '6/00-06



Header	435 x 60	Core	MER096PA
O Ring/Gasket		T/B Tank	
Condenser			
Notes	Includes Sensor Hole		ADRAD RADIATORS

SPRINTER VAN Auto. '10/06-



Header	417 x 49	Core	
O Ring/Gasket		T/B Tank	
Condenser	CMER70K		
Notes	Outlet Hose is Clip On		ADRAD RADIATORS

UNIMOG Army Truck





Header	595 x 66	Core	MER841
O Ring/Gasket		T/B Tank	
Condenser			
Notes			ADRAD RADIATORS

Header		Core	
O Ring/Gasket		T/B Tank	
Condenser			
Notes			

METROTEC

BUS



Header	769 x 70	Core	INT004
O Ring/Gasket		T/B Tank	
Condenser			
Notes			

METROTEC

DELTA BUS



Header	769 x 70	Core	INT004
O Ring/Gasket		T/B Tank	
Condenser			
Notes	90 Degree Pipe Grille Side		

DELTA BUS

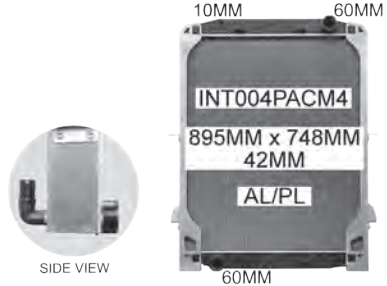

Header	769 x 70	Core	INT004
O Ring/Gasket		T/B Tank	
Condenser			
Notes	90 Degree Pipe Grille Side		

MITSUBISHI

BUS Man. '85-



Header	485 x 66	Core	MIT951
O Ring/Gasket		T/B Tank	MIT951BT/BB
Condenser			
Notes			

MITSUBISHI

CANTER Man.

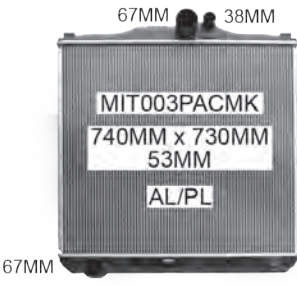

Header	760 x 75	Core	
O Ring/Gasket	OR760X76F	T/B Tank	
Condenser			
Notes	FP547 / FS527 / FV547		

CANTER Man. '88-



Header	475 x 50	Core	MIT9106
O Ring/Gasket		T/B Tank	
Condenser			
Notes			

CANTER 3.5T Man. '98-

Header	488 x 68	Core	MIT015
O Ring/Gasket		T/B Tank	
Condenser			
Notes			

CANTER 3.5T Man. '98-

Header	496 x 62	Core	
O Ring/Gasket		T/B Tank	
Condenser			
Notes			

CANTER 5.5T Man. '96-

Header	544 x 54	Core	
O Ring/Gasket	OR544X54R	T/B Tank	MIT011PT/PB
Condenser			
Notes			

CANTER 5.5T Man. '96-

Header	555 x 55	Core	
O Ring/Gasket		T/B Tank	
Condenser			
Notes			

CANTER FE331/444 Man.

Header	485 x 66	Core	MIT951
O Ring/Gasket		T/B Tank	MIT951BT/BB
Condenser			
Notes			

CANTER FE649 Man.

Header	544 x 54	Core	
O Ring/Gasket	OR544X54R	T/B Tank	MIT011PT/PB
Condenser			
Notes			

CANTER FE649 Man.

Header	555 x 55	Core	
O Ring/Gasket		T/B Tank	
Condenser			
Notes			

CANTER FE71E / FE73E Man. '05-

Header	460 x 68	Core	
O Ring/Gasket		T/B Tank	
Condenser			
Notes	4M51 Engine		

CANTER FE83 Man. '06-



Header	537 x 70	Core	
O Ring/Gasket		T/B Tank	
Condenser			
Notes	4M50 Engine		

CANTER FE84/85 Man. '07-



Header	540 x 66	Core	
O Ring/Gasket		T/B Tank	
Condenser			
Notes			

CANTER FG Man.



Header	488 x 68	Core	MIT015
O Ring/Gasket		T/B Tank	
Condenser			
Notes			

CANTER FG Man.



Header	496 x 62	Core	
O Ring/Gasket		T/B Tank	
Condenser			
Notes			

CANTER FG Man.



Header	544 x 54	Core	
O Ring/Gasket	OR544X54R	T/B Tank	MIT011PT/PB
Condenser			
Notes			

CANTER FG Man.



Header	555 x 55	Core	
O Ring/Gasket		T/B Tank	
Condenser			
Notes			

CANTER FG73E Man. '05-



Header	460 x 68	Core	
O Ring/Gasket		T/B Tank	
Condenser			
Notes	4M51 Engine		

CANTER FG84 Man. '08-10



Header	537 x 69	Core	
O Ring/Gasket		T/B Tank	
Condenser			
Notes	PDG-FE83DY		

FORKLIFT FG25 Auto.



Header	465 x 69	Core	
O Ring/Gasket	OR466X67R	T/B Tank	
Condenser			
Notes			

FORKLIFT FGE15ZN / FGE25ZN Auto.



Header	465 x 69	Core	
O Ring/Gasket	OR466X67R	T/B Tank	
Condenser			
Notes			

FUSO FK / FM Man. '95-02



Header		Core	
O Ring/Gasket		T/B Tank	
Condenser			
Notes			

FUSO FK / FM Man.



Header	622 x 68	Core	MIT017
O Ring/Gasket		T/B Tank	MIT017PT/PB
Condenser			
Notes			

FUSO FK / FM Man.



Header	622 x 68	Core	
O Ring/Gasket		T/B Tank	
Condenser			
Notes	SL Core		

FUSO FK600 Man. '07-



Header	631 x 70	Core	MIT051PA
O Ring/Gasket	OR627X51R	T/B Tank	MIT051PT
Condenser			
Notes	6M60 Engine		

FUSO FK617 Man. '92-98



Header	623 x 70	Core	
O Ring/Gasket	OR622X70R	T/B Tank	
Condenser			
Notes	Sensor Hole on Inlet Tank		

FUSO FK65F Man. '09-



Header	631 x 70	Core	
O Ring/Gasket		T/B Tank	
Condenser			
Notes	Sensor Hole on Inlet Tank		

FUSO FP / FS / FV / FT Man. '98-

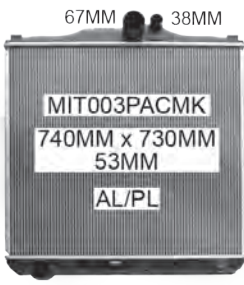

67MM 38MM
MIT003PACMK
740MM x 730MM
53MM
AL/PL
67MM

Header	760 x 75	Core	
O Ring/Gasket	OR760X76F	T/B Tank	
Condenser			
Notes	FP547 / FS527 / FV547		

FUSO FP Man. '11-



10MM 67MM
MIT059PACM
905MM x 750MM
48MM
AL/PL
64MM

Header	760 x 70	Core	
O Ring/Gasket		T/B Tank	
Condenser			
Notes	FP54		

FUSO FP Man. '08-



67MM 38MM
MIT016PACM2K
850MM x 730MM
53MM 2-ROW
AL/PL
67MM

Header	760 x 75	Core	MIT016
O Ring/Gasket	OR760X76F	T/B Tank	MIT016PT
Condenser			
Notes			

FUSO FV Man. '96-



67MM 38MM
MIT016PACM2K
850MM x 730MM
53MM 2-ROW
AL/PL
67MM

Header	760 x 75	Core	MIT016
O Ring/Gasket	OR760X76F	T/B Tank	MIT016PT
Condenser			
Notes			

FUSO FV Man. '11-



10MM 67MM
MIT059PACM
905MM x 750MM
48MM
AL/PL
64MM

Header	760 x 70	Core	
O Ring/Gasket		T/B Tank	
Condenser			
Notes	FV54		

FUSO FIGHTER FK61 Man. '04-



46MM
MIT051PACM
670MM x 618MM
48MM 2-ROW
AL/PL
46MM

Header	631 x 70	Core	MIT051PA
O Ring/Gasket	OR627X51R	T/B Tank	MIT051PT
Condenser			
Notes	6M60 Engine		

FUSO FIGHTER NK64 Man. '09-



46MM
MIT054PACM
750MM x 618MM
48MM 1-ROW
AL/PL
46MM

Header	631 x 70	Core	
O Ring/Gasket		T/B Tank	
Condenser			
Notes	Sensor Hole on Inlet Tank		

FUSO FIGHTER SN / SM Man.



46MM
MIT017PACMK
630MM x 608MM
36MM 2-ROW
AL / PL
46MM

Header	622 x 68	Core	MIT017
O Ring/Gasket		T/B Tank	MIT017PT/PB
Condenser			
Notes			

FUSO FIGHTER SN / SM Man.



Header	622 x 68	Core	
O Ring/Gasket		T/B Tank	
Condenser			
Notes	SL Core		

FUSO SUPER GREAT FS / FT / FV Man. '97-



Header	759 x 75	Core	
O Ring/Gasket	OR760X74R	T/B Tank	MIT050PB2
Condenser			
Notes	FS/FT/FV/KC/KL		

FUSO SUPER GREAT FV Man. '03-



Header	759 x 75	Core	
O Ring/Gasket	OR760X74R	T/B Tank	MIT050PB
Condenser			
Notes			

FUSO SUPER GREAT FV513 Man. '96-97



Header	760 x 75	Core	MIT016
O Ring/Gasket	OR760X76F	T/B Tank	MIT016PT
Condenser			
Notes			

FUSO SUPER GREAT KC / KL Man. '97-



Header	759 x 75	Core	
O Ring/Gasket	OR760X74R	T/B Tank	MIT050PB2
Condenser			
Notes	FS/FT/FV/KC/KL		

FUSO Man. '09-



Header	537 x 69	Core	
O Ring/Gasket		T/B Tank	
Condenser			
Notes	PDG-FE83DY		

ROLLER



Header	465 x 69	Core	
O Ring/Gasket		T/B Tank	
Condenser			
Notes			

ROSA BUS Man. '04-



Header	622 x 69	Core	MIT032
O Ring/Gasket	OR622X70R	T/B Tank	MIT032PT
Condenser			
Notes	4M51, 4D33, 4M50 Engines		

ROSA BUS Man. '08-



Header	631 x 69	Core	
O Ring/Gasket	OR622X70R	T/B Tank	
Condenser			
Notes			

NORMET

NORMET

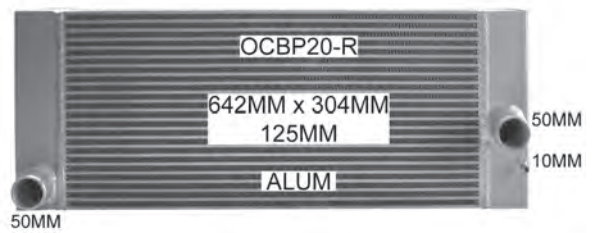

Header		Core	
O Ring/Gasket		T/B Tank	
Condenser			
Notes	Bar & Plate		

NEW HOLLAND

TRACTOR Auto.



Header	560 x 146	Core	
O Ring/Gasket		T/B Tank	
Condenser			
Notes			

TRACTOR M60 Auto.



Header	534 x 122	Core	
O Ring/Gasket		T/B Tank	
Condenser			
Notes			

TRACTOR 7840 / 8240 / 8340 Auto.



Header		Core	
O Ring/Gasket		T/B Tank	
Condenser			
Notes			

MITSUBISHI

NORMET

NEW HOLLAND

NEW HOLLAND

TRACTOR TS90 / 100 / 110 / 115 Auto. '99-



Header	512 x 120	Core	
O Ring/Gasket		T/B Tank	
Condenser			
Notes			

NISSAN

NISSAN

FORKLIFT Auto.



Header	437 x 77	Core	
O Ring/Gasket		T/B Tank	
Condenser			
Notes			

FORKLIFT Auto.



Header	460 x 70	Core	
O Ring/Gasket		T/B Tank	
Condenser			
Notes			

FORKLIFT Auto.



Header	465 x 69	Core	
O Ring/Gasket	OR466X67R	T/B Tank	
Condenser			
Notes			

FORKLIFT 2.5 TONNE Auto.



Header	544 x 74	Core	
O Ring/Gasket		T/B Tank	
Condenser			
Notes			

FORKLIFT 2.5 TONNE Auto.



Header	460 x 70	Core	
O Ring/Gasket		T/B Tank	
Condenser			
Notes			

FORKLIFT 2.5 TONNE Auto.

Header	460 x 70	Core	
O Ring/Gasket		T/B Tank	
Condenser			
Notes			

UD CW385 Man. '03-07

Header	713 x 76	Core	
O Ring/Gasket	OR713X76R	T/B Tank	
Condenser			
Notes			

UD CW445 Man. '03-07

Header	713 x 76	Core	
O Ring/Gasket	OR713X76R	T/B Tank	
Condenser			
Notes			

UD CW445/480 '05-

Header	493 x 53	Core	
O Ring/Gasket	OR493X52R	T/B Tank	
Condenser			
Notes	Auxillary Radiator		

UD CW450 Man. '03-10

Header	706 x 56	Core	
O Ring/Gasket		T/B Tank	
Condenser			
Notes			

UD CWA / CDA214 Man. 01-

Header	603 x 56	Core	
O Ring/Gasket		T/B Tank	
Condenser			
Notes			

UD CWB385 / CWB483 Man. '03-

Header		Core	
O Ring/Gasket		T/B Tank	
Condenser			
Notes			

UD CWM430 Man. '90-01

Header	706 x 56	Core	
O Ring/Gasket		T/B Tank	
Condenser			
Notes			

UD CWB440 Man. '02-



Header	713 x 76	Core	NIS065PA
O Ring/Gasket	OR713X76R	T/B Tank	NIS065PT/PB
Condenser			
Notes			

UD GW / GWB Man. '08-



Header	746 x 76	Core	
O Ring/Gasket		T/B Tank	
Condenser			
Notes			

UD GW400 Man. '08-



Header		Core	
O Ring/Gasket		T/B Tank	
Condenser			
Notes			

UD GW470 Man. '08-



Header	746 x 76	Core	
O Ring/Gasket		T/B Tank	
Condenser			
Notes			

UD LK260 Man. '99-



Header	613 x 52	Core	NIS080PA
O Ring/Gasket	OR614X52R	T/B Tank	NIS080PT
Condenser			
Notes	Outlet Pipe on Grille Side		

UD MK150 / MK175 Man. '99-06



Header	548 x 52	Core	
O Ring/Gasket	OR547X50R	T/B Tank	
Condenser			
Notes			

UD MK245 Man. '04-07



Header	613 x 52	Core	NIS080PA
O Ring/Gasket	OR614X52R	T/B Tank	
Condenser			
Notes			

UD MK260 Man. '99-



Header	613 x 52	Core	NIS080PA
O Ring/Gasket	OR614X52R	T/B Tank	NIS080PT
Condenser			
Notes	Outlet Pipe on Grille Side		

UD PK9/PK10 Man. '08-



Header	Core
O Ring/Gasket	T/B Tank
Condenser	
Notes	

UD PK245 / PK260 / PK265 Man.



Header	613 x 52	Core	NIS080PA
O Ring/Gasket	OR614X52R	T/B Tank	
Condenser			
Notes			

UD PKB214 / PKC211H Man. '06-



Header	603 x 56	Core	
O Ring/Gasket		T/B Tank	
Condenser			
Notes			

UD PKC37 Man. '08-



Header		Core	
O Ring/Gasket		T/B Tank	
Condenser			
Notes			

QUON Man.



Header	746 x 76	Core	
O Ring/Gasket		T/B Tank	
Condenser			
Notes			

QUON GWB4D Man.



Header		Core	
O Ring/Gasket		T/B Tank	
Condenser			
Notes			

PJ BERRIMAN

MINE CRUISER 2 MWM SERIES 10

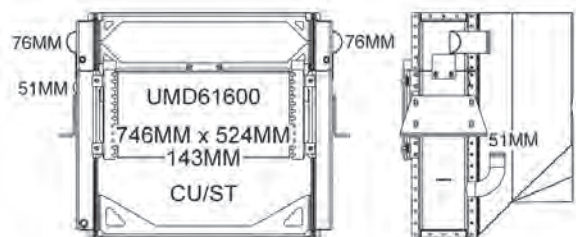

Header		Core	
O Ring/Gasket		T/B Tank	
Condenser			
Notes			

PJ BERRIMAN

MINE CRUISER MK4.5



Image Not Currently Available

XMW22260

Header	601 x 215	Core	PJB701
O Ring/Gasket	X001023A/C6327K	T/B Tank	
Condenser			
Notes			

RENAULT

RENAULT

TRAFIC X83 1.9ltr Turbo Diesel Man. '5/04-



Header	472 x 42	Core	
O Ring/Gasket	OR470X45R	T/B Tank	
Condenser	CREN07		
Notes			

TRAFIC X83 2.0ltr Turbo Diesel Man. '07-



Header	472 x 42	Core	
O Ring/Gasket	OR470X45R	T/B Tank	
Condenser	CREN07		
Notes	85kw Engine		

MASTER X70 2.5ltr Turbo Diesel Man. '04-4/07



Header	415 x 43	Core	
O Ring/Gasket	T/B Tank		
Condenser			
Notes			

MASTER X70 2.5ltr Turbo Diesel Man. '5/07-11



Header	431 x 60	Core	
O Ring/Gasket	T/B Tank		
Condenser			
Notes			

MASTER X62 2.3ltr Turbo Diesel Man. '9/11-



Header	495 x 44	Core	
O Ring/Gasket	T/B Tank		
Condenser	CREN25		
Notes			

SANDVIK

LOADER

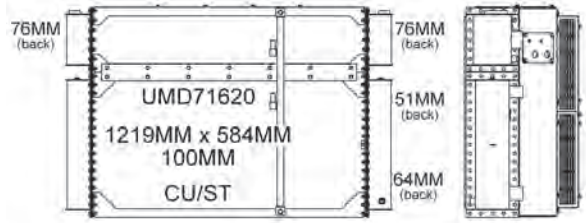

Header		Core	
O Ring/Gasket		T/B Tank	
Condenser			
Notes	CAT C7 Engine		

SANDVIK

SCANIA

BUS K320 '09-



Header	1028 x 60	Core	
O Ring/Gasket		T/B Tank	
Condenser			
Notes			

SCANIA

BUS K420 '07-



Header	720 x 66	Core	
O Ring/Gasket		T/B Tank	
Condenser	CSCA01		
Notes			

P/G/R SERIES Man. '04-



Header	720 x 66	Core	
O Ring/Gasket		T/B Tank	
Condenser	CSCA01		
Notes			

P112 / P113 Man.



Header	780 x 94	Core	SCA911
O Ring/Gasket		T/B Tank	
Condenser			
Notes			

P SERIES 94/104/114/124D/144 Man. '8/95-



Header	719 x 72	Core	SCA004PA
O Ring/Gasket		T/B Tank	
Condenser			
Notes			

SCANIA

P270 / P380 Man. '04-



Header	1028 x 60	Core	
O Ring/Gasket		T/B Tank	
Condenser			
Notes			

R94 / R124 / R144 Man. '96-04



Header	965 x 72	Core	SCA002
O Ring/Gasket	OR964X72F	T/B Tank	SCA002PTB
Condenser			
Notes			

R112 / R113 Man.



Header	780 x 94	Core	SCA911
O Ring/Gasket		T/B Tank	
Condenser			
Notes			

T94 / T124 / T144 '96-02



Header	965 x 72	Core	SCA002
O Ring/Gasket	OR964X72F	T/B Tank	SCA002PTB
Condenser	CSCA01		
Notes			

T112 / T113 Man.



Header	780 x 94	Core	SCA911
O Ring/Gasket		T/B Tank	
Condenser			
Notes			

Header		Core	
O Ring/Gasket		T/B Tank	
Condenser			
Notes			

STATIONARY

STATIONARY ENGINES

CATERPILLAR CRUSHER PLANT



Header	641 x 85	Core	
O Ring/Gasket		T/B Tank	
Condenser			
Notes			

CATERPILLAR CRUSHER PLANT



Header	455 x 125	Core	
O Ring/Gasket		T/B Tank	
Condenser			
Notes	Caterpillar Engine		

CATERPILLAR GENSET



Header	455 x 125	Core	
O Ring/Gasket		T/B Tank	
Condenser			
Notes	Caterpillar Engine		

CATERPILLAR GENSET



Header		Core	
O Ring/Gasket		T/B Tank	
Condenser			
Notes			

CATERPILLAR GENSET

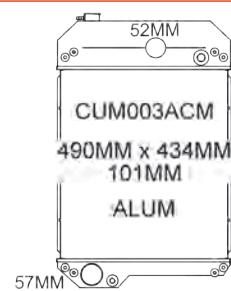

Header	450 x 124	Core	
O Ring/Gasket		T/B Tank	
Condenser			
Notes			

CATERPILLAR SCREENING PLANT



Header	455 x 125	Core	
O Ring/Gasket		T/B Tank	
Condenser			
Notes	Caterpillar Engine		

CATERPILLAR STATIONARY ENGINE



Header	465 x 69	Core	
O Ring/Gasket		T/B Tank	
Condenser			
Notes			

CUMMINS 4B/4BT

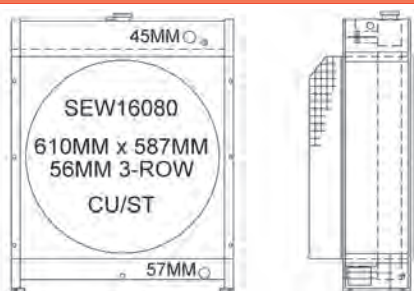

Header		Core	
O Ring/Gasket		T/B Tank	
Condenser			
Notes			

CUMMINS 4B/4BTG1/4BTG2



Header	601 x 140	Core	SP-1213/3ML11
O Ring/Gasket	SP-1283/C6327K	T/B Tank	SBS-2-1591 / SBS-3-1591
Condenser			
Notes			

STATIONARY

CUMMINS 6B/6BT

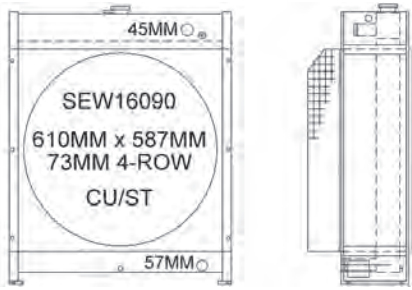

Header	Core
O Ring/Gasket	T/B Tank
Condenser	
Notes	

CUMMINS 6B/6BTG1/6BTG2



Header	601 x 140	Core	SP-1223/4ML11
O Ring/Gasket	SP-1283/C6327K	T/B Tank	SBS-2-1591 / SBS-3-1591
Condenser			
Notes			

CUMMINS 6BTA



Header	730 x 140	Core	
O Ring/Gasket	SP-1286/C6327K	T/B Tank	
Condenser			
Notes			

CUMMINS 6CT/CTA

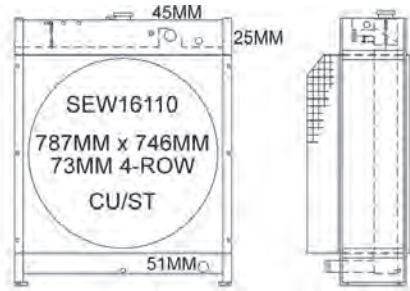

Header	816 x 140	Core	
O Ring/Gasket	SP-1288/C6327K	T/B Tank	
Condenser			
Notes			

CUMMINS 6TA 8.3ltr

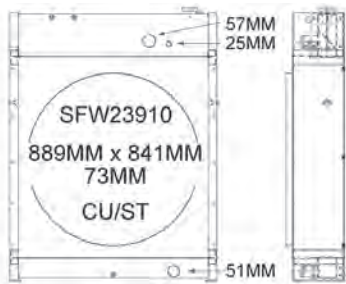

Header	Core
O Ring/Gasket	T/B Tank
Condenser	
Notes	

CUMMINS GENSET



Header	450 x 124	Core	
O Ring/Gasket		T/B Tank	
Condenser			
Notes			

CUMMINS KTA19G2/KTTA19 G1 - G2

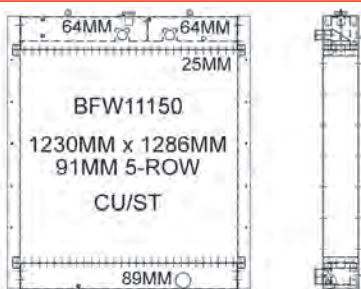

Header	1362 x 178	Core	B11150/5MLF11
O Ring/Gasket	SP-622/C6327K	T/B Tank	
Condenser			
Notes			

CUMMINS M11

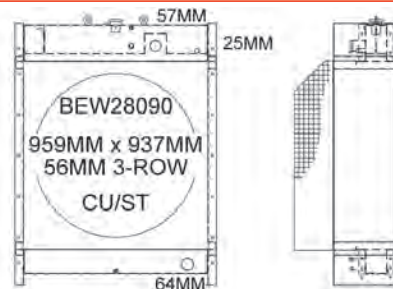

Header	Core
O Ring/Gasket	T/B Tank
Condenser	
Notes	

CUMMINS NT855 G4-G5

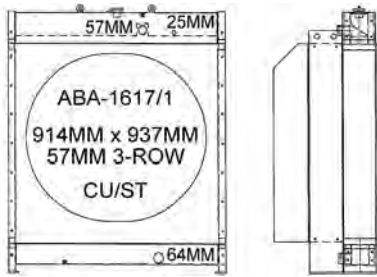

Header	1019 x 178	Core	ABA-1617/3MLF11
O Ring/Gasket	SP-375/C6327K	T/B Tank	
Condenser			
Notes	Radiator / Plenum		

CUMMINS NT855 G6

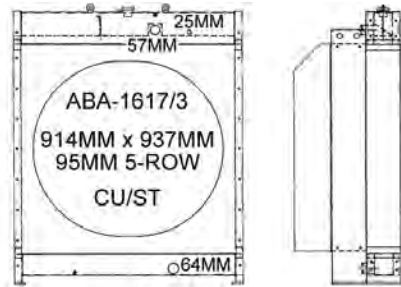

Header	1019 x 178	Core	ABA-1617/5MLF11
O Ring/Gasket	SP-375/C6327K	T/B Tank	
Condenser			
Notes			

CUMMINS NTA855

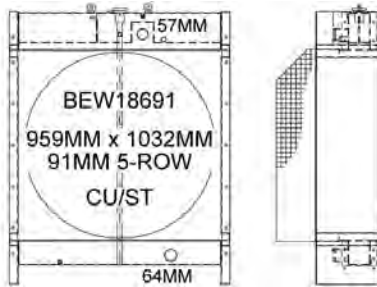

Header		Core	
O Ring/Gasket		T/B Tank	
Condenser			
Notes	450HP		

CUMMINS NTA855

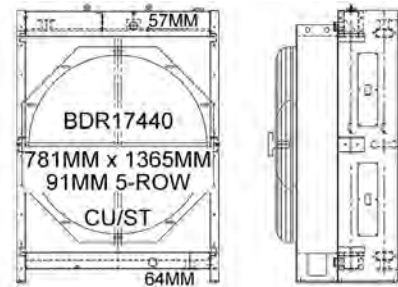

Header		Core	
O Ring/Gasket		T/B Tank	
Condenser			
Notes	Radiator / Oil Cooler / Plenum		

CUMMINS NTA855 G3

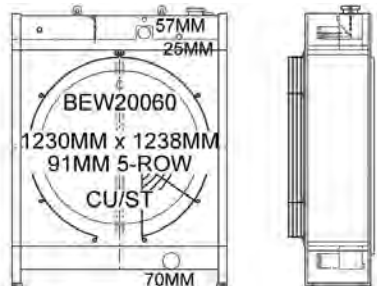

Header		Core	
O Ring/Gasket		T/B Tank	
Condenser			
Notes			

DETROIT 6V92TA

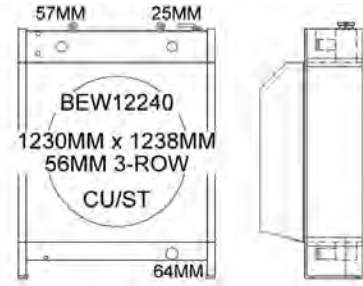

Header		Core	
O Ring/Gasket		T/B Tank	
Condenser			
Notes			

DETROIT 12V71T

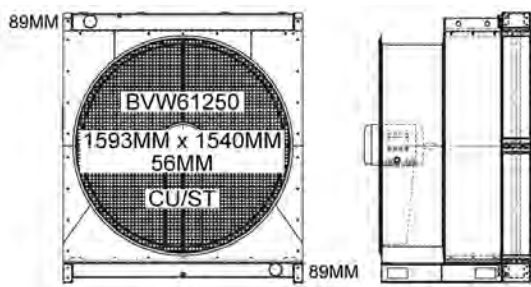

Header		Core	
O Ring/Gasket		T/B Tank	
Condenser			
Notes	2 Cores		

DETROIT 12V71TA Panel & Plenum

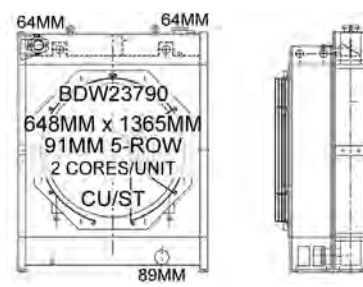

Header		Core	
O Ring/Gasket		T/B Tank	
Condenser			
Notes	B18 / Radiator / Plenum		

DETROIT 12V92TA Panel & Plenum

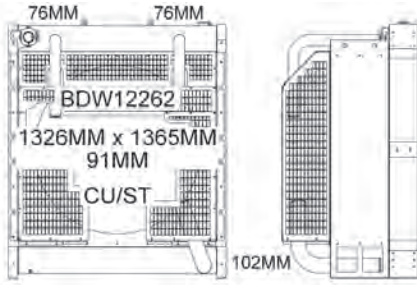

Header	1148 x 178	Core	SP-564/5MLF11
O Ring/Gasket	SP-632/C6327K	T/B Tank	
Condenser			
Notes	B18A / Radiator / Plenum (2 Cores per unit)		

DETROIT 16V92TA

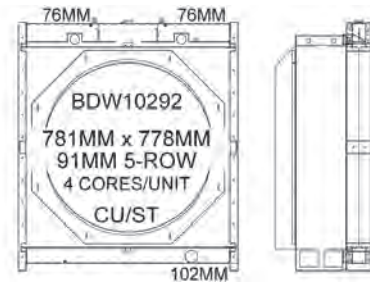

Header		Core	
O Ring/Gasket		T/B Tank	
Condenser			
Notes			

DETROIT 16V92TA

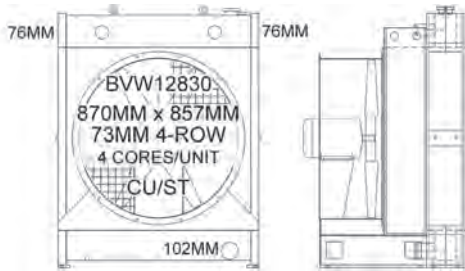

Header		Core	
O Ring/Gasket		T/B Tank	
Condenser			
Notes	830HP		

DETROIT 6V71T

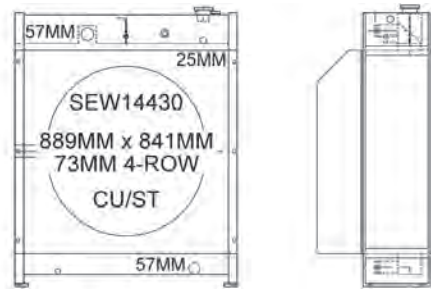

Header		Core	
O Ring/Gasket		T/B Tank	
Condenser			
Notes	SIO COMBI		

DETROIT 6V71TA

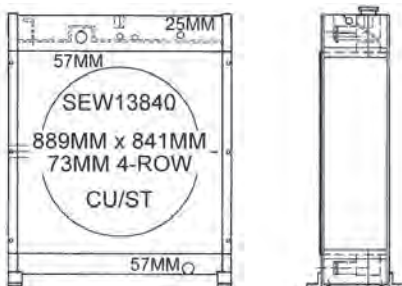

Header	902 x 140	Core	SP-1230/4MLF11
O Ring/Gasket	SP-1290/C6327K	T/B Tank	
Condenser			
Notes	Also suit Bliss-fox Tractor		

DETROIT 6V71TA

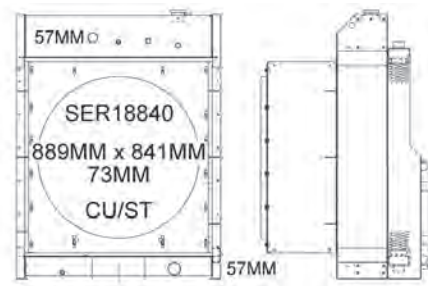

Header		Core	
O Ring/Gasket		T/B Tank	
Condenser			
Notes	UDR1500 Drill Rig		

DETROIT Diesel D706LT

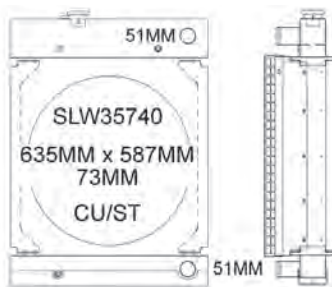

Header	644 x 140	Core	S20441/4ML11
O Ring/Gasket		T/B Tank	
Condenser			
Notes			

DETROIT Series 50



Image Not Currently Available

WMD23250

Header		Core	
O Ring/Gasket		T/B Tank	
Condenser			
Notes	Includes Radiator / CAC / Cowl		

KOMATSU GENSET



Header	465 X 69	Core	
O Ring/Gasket		T/B Tank	
Condenser			
Notes	Also Suit Denyo		

KUBOTA STATIONARY ENGINE



Header	407 x 69	Core	KUB006
O Ring/Gasket		T/B Tank	
Condenser			
Notes			

KUBOTA V3300

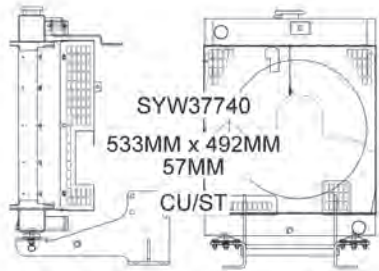

Header	559 x 140	Core	SP-1212/3ML12
O Ring/Gasket	SP-1282/C6327K	T/B Tank	
Condenser			
Notes	Industrial Rad/Guard/ Plumbing & Mounting kit		

MITSUBISHI STATIONARY ENGINE



Header	465 x 69	Core	
O Ring/Gasket		T/B Tank	
Condenser			
Notes			

ONAN 130-3587

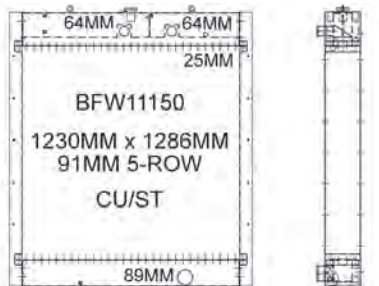

Header	1362 x 178	Core	B11150/5MLF11
O Ring/Gasket	SP-622/C6327K	T/B Tank	
Condenser			
Notes			

ONAN L634D

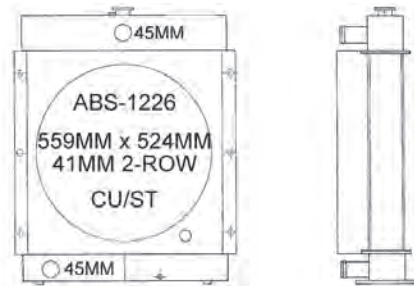

Header		Core	
O Ring/Gasket		T/B Tank	
Condenser			
Notes	Radiator / Cowl		

PERKINS 1006-6 / 1006-6T / 1006-6TW

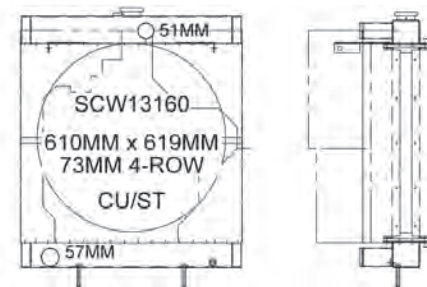

Header		Core	
O Ring/Gasket		T/B Tank	
Condenser			
Notes			

PERKINS 1006-67G

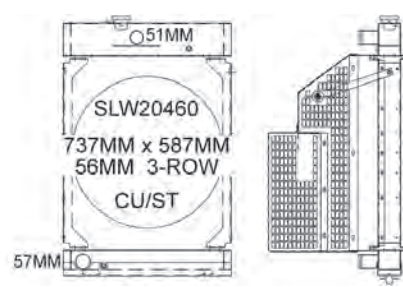

Header		Core	
O Ring/Gasket		T/B Tank	
Condenser			
Notes	105kW		

Universal Cooling Units

FOR A VARIETY OF MOBILE /
STATIONARY APPLICATIONS

Australian Designed & Manufactured

11FPI Copper Louvred Tubular Core

All Steel Tanks & Surrounds

Delivered in kit form as shown

Part Number	Core Size mm			Max HP
	A	B	C	
C4652-85HPUV	546	470	45	85
C4653-100HPUV	610	584	45	100
C4654-177HPUV	710	660	45	177

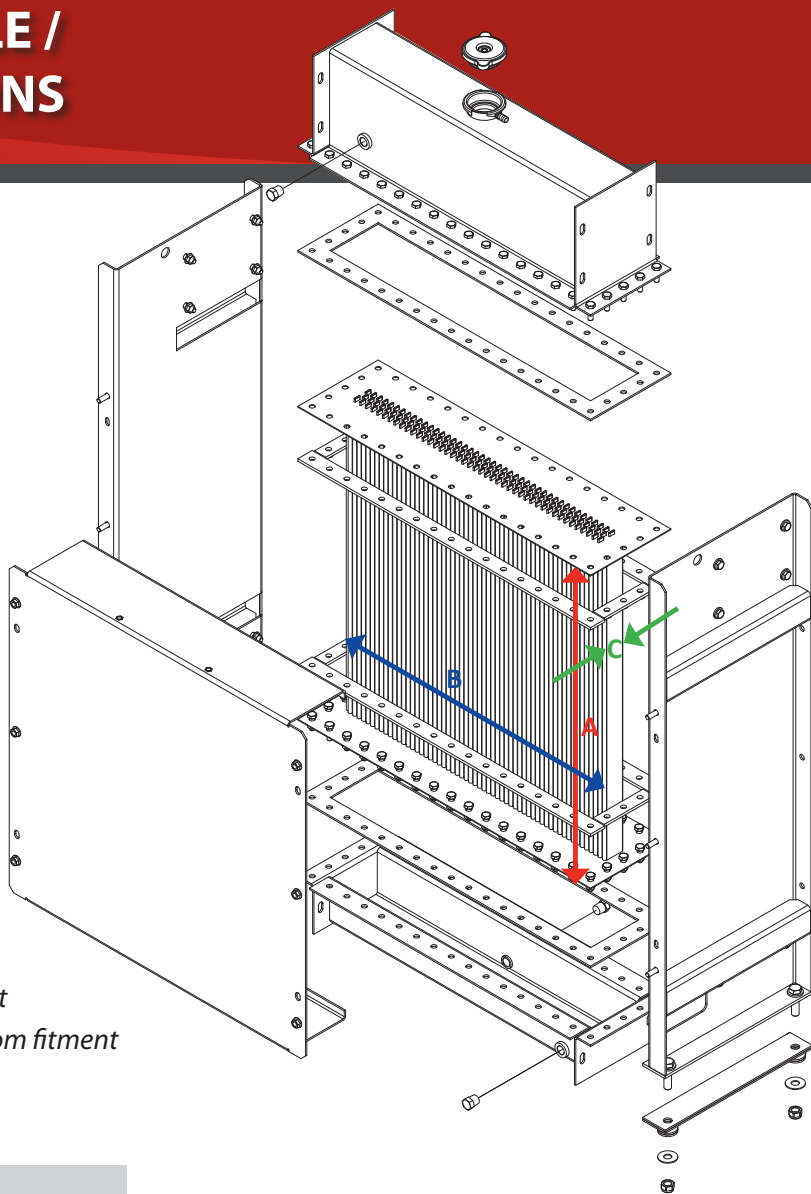

VERSATILE DESIGN

- Fan Shroud is uncut to allow for custom fan fitment
- Tanks do not include Inlet /Outlet to allow for custom fitment
- Engine Driven Fans available to order

OPTIONAL INLET / OUTLET MILD STEEL FITTINGS



Part Number	Mild Steel Fittings mm
SP-1670	25 OD x 48 LONG
SP-2743	32 OD x 79 LONG
SP-2744	38 OD x 79 LONG
SP-2745	45 OD x 79 LONG
SP-2746	51 OD x 79 LONG
SP-2747	57 OD x 79 LONG
SP-2748	64 OD x 79 LONG



Adrad is a Quality Accredited
OE Manufacturer & Supplier



PERKINS 1006-6N

Header	601 x 140	Core	S11450/4ML11
O Ring/Gasket	SP-1283/C6327K	T/B Tank	
Condenser			
Notes	Radiator / Oil Cooler / Cowl		

PERKINS 1006TD

Header		Core	
O Ring/Gasket		T/B Tank	
Condenser			
Notes			

PERKINS 1104A-44T

Header	644 x 140	Core	SL-1998/3SL9SC
O Ring/Gasket	62042001 / 64694002	T/B Tank	
Condenser			
Notes			

PERKINS 1306-9T / 1306-9TG1

Header		Core	
O Ring/Gasket		T/B Tank	
Condenser			
Notes			

PERKINS 1306-9TAG / 1306-9TA1

Header	JW: 633 x 178 CAC: 461 x 178	Core	JW: B18510/5MLF9 CAC: B18510/4CAF7
O Ring/Gasket	JW: SP-366/C6327K CAC: 41851012	T/B Tank	
Notes			

PERKINS 4.236

Header	559 x 140	Core	SP-1212/3ML9
O Ring/Gasket	SP-1282/C6327K	T/B Tank	
Condenser			
Notes			

PERKINS GENSET

Header		Core	PER008PA
O Ring/Gasket		T/B Tank	
Condenser			
Notes	XD75		

PERKINS GENSET

Header	455 x 125	Core	
O Ring/Gasket		T/B Tank	
Condenser			
Notes	Caterpillar Engine		

PERKINS GENSET



Header	556 x 96	Core
O Ring/Gasket		T/B Tank
Condenser		
Notes		

PERKINS GENSET



Header		Core
O Ring/Gasket		T/B Tank
Condenser		
Notes		

PERKINS LIGHTING TOWER

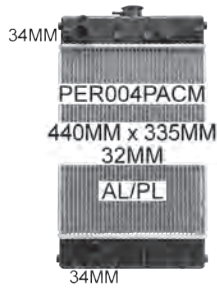

Header	348 x 56	Core
O Ring/Gasket		T/B Tank
Condenser		
Notes		

PERKINS LIGHTING TOWER



Header	345 x 49	Core
O Ring/Gasket		T/B Tank
Condenser		
Notes		

PERKINS LIGHTING TOWER



Header	345 x 49	Core
O Ring/Gasket		T/B Tank
Condenser		
Notes		

PERKINS LIGHTING TOWER



Header		Core	PER005/N
O Ring/Gasket		T/B Tank	
Condenser			
Notes			

PERKINS STATIONARY ENGINE



Header	451 x 123	Core
O Ring/Gasket		T/B Tank
Condenser		
Notes	Crushing Plant	

PERKINS T4.236

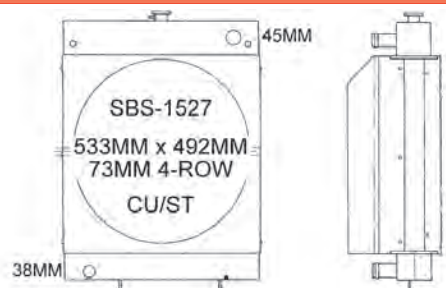

Header	559 x 140	Core	SP-1222/4ML9
O Ring/Gasket	SP-1282/C6327K	T/B Tank	SBS-2-1527 / SBS-3-1527
Condenser			
Notes			

SULLAIR 900/350 COMPRESSOR

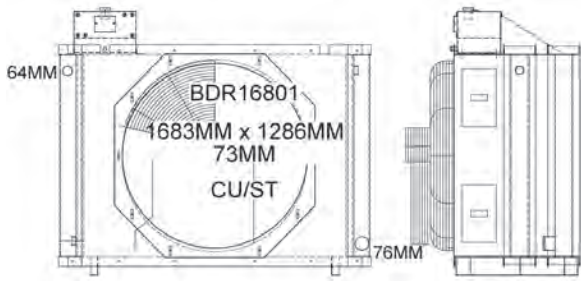

Header	Core	
O Ring/Gasket	T/B Tank	
Condenser		
Notes	Caterpillar 3406 Engine	

VERMEER 305 STUMP GRINDER



Header	407 x 69	Core	YAN002
O Ring/Gasket		T/B Tank	
Condenser			
Notes			

WAUKESHA Engine LS5108GSI

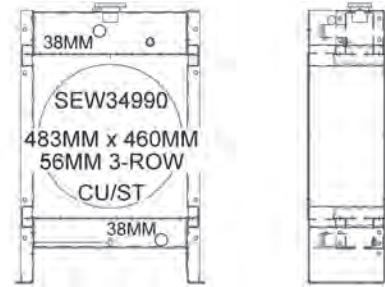

Image Not Currently Available

BHW10030

Header	Core	
O Ring/Gasket	T/B Tank	
Condenser		
Notes	Low Temp Panel	

YANMAR 4TNE98



Header	Core	
O Ring/Gasket	T/B Tank	
Condenser		
Notes	68hp	

YANMAR ELECTRIC GENERATOR



Header	407 x 69	Core	YAN002
O Ring/Gasket		T/B Tank	
Condenser			
Notes			

YANMAR FORKLIFT



Header	408 x 70	Core	YAN001
O Ring/Gasket		T/B Tank	
Condenser			
Notes			

YANMAR POWER EQUIPMENT



Header	367 x 54	Core	
O Ring/Gasket		T/B Tank	
Condenser			
Notes			

YANMAR STATIONARY ENGINE



Header	407 x 69	Core	KUB006
O Ring/Gasket		T/B Tank	
Condenser			
Notes			

TAMROCK

TAMROCK

720

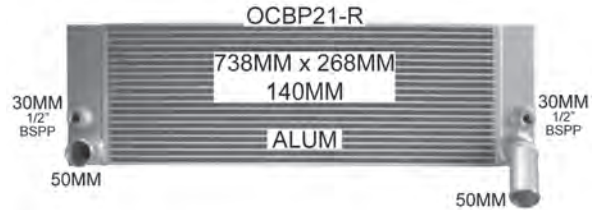

Header		Core	
O Ring/Gasket		T/B Tank	
Condenser			
Notes	Bar & Plate / Pressure Rating = 2 Bar		

TCM

TCM

FORKLIFT FD40T9 4 TONNE Auto.



Header	544 x 75	Core	TCM001
O Ring/Gasket	OR544X75R	T/B Tank	
Condenser			
Notes	Diesel		

TEREX

TEREX

FRANNA CRANE AT5

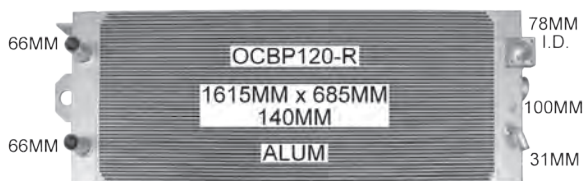

Image Not Currently Available

YFW28130

Header	652 x 90	Core	ML-1608
O Ring/Gasket		T/B Tank	82813001 / 82813002
Condenser			
Notes			

RH120E SHOVEL



Header		Core	
O Ring/Gasket		T/B Tank	
Condenser			
Notes	Bar & Plate		

Header		Core	
O Ring/Gasket		T/B Tank	
Condenser			
Notes			

TOYOTA

TOYOTA

COASTER HDB / HZB Auto. '97-04

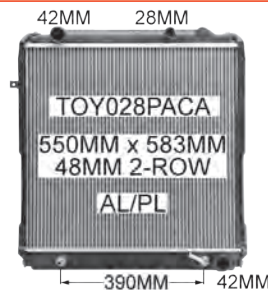

Header	598 x 70	Core	TOY028/PA
O Ring/Gasket	OR596X72R	T/B Tank	TOY028PT
Condenser			
Notes			

COASTER HDB / HZB Man. '97-04



Header	598 x 70	Core	TOY028/PA
O Ring/Gasket	OR596X72R	T/B Tank	TOY028PT
Condenser			
Notes			

COASTER RB11 Man. '79-82



Header	528 x 54	Core	
O Ring/Gasket		T/B Tank	
Condenser			
Notes			

COASTER BB50 Man. '05-

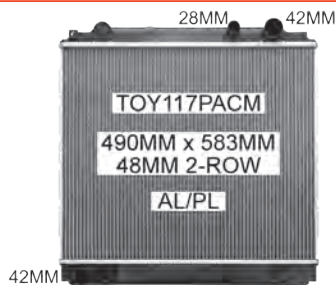

Header	597 x 69	Core	
O Ring/Gasket	OR596X72R	T/B Tank	
Condenser			
Notes	15B Engine		

DYNA BU82 / BU87 Man. '85-90



Header	528 x 54	Core	
O Ring/Gasket		T/B Tank	
Condenser			
Notes			

DYNA BU91R Man. '88-95



Header	615 x 60	Core	TOY9197
O Ring/Gasket		T/B Tank	TOY9197BT/BB
Condenser			
Notes			

DYNA BU212R / BU222R Man.

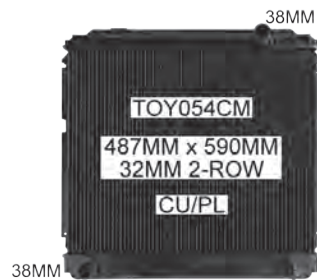

Header	613 x 70	Core	TOY054
O Ring/Gasket		T/B Tank	TOY054PT
Condenser			
Notes			

DYNA HZB50R Man.



Header	598 x 60	Core	TOY9292
O Ring/Gasket		T/B Tank	TOY9292BT
Condenser			
Notes			

DYNA Man. '96-



Header	545 x 70	Core	TOY021
O Ring/Gasket	OR545X70R	T/B Tank	TOY021PT/PB
Condenser	CTOY51		
Notes			

DYNA 100 / 150 Series Man. '01-



Header	494 x 69	Core	TOY9686PA
O Ring/Gasket	OR495X66R	T/B Tank	
Condenser			
Notes	LY220 / LY230 / LY240		

DYNA 300 Series Man. '03-



Header	494 x 69	Core	
O Ring/Gasket	OR495X66R	T/B Tank	
Condenser			
Notes			

DYNA 300 Series Auto. '05-07



Header	581 x 54	Core	HIN078PA
O Ring/Gasket	OR582X55S	T/B Tank	HIN078PT
Condenser			
Notes			

DYNA 300 Series Man. '05-07



Header	581 x 54	Core	HIN078PA
O Ring/Gasket	OR582X55S	T/B Tank	HIN078PT/PB
Condenser			
Notes			

DYNA 300 Series Auto. '07-



Header	494 x 69	Core	
O Ring/Gasket	OR495X66R	T/B Tank	HIN007PT
Condenser			
Notes			

DYNA 300 Series Man. '07-

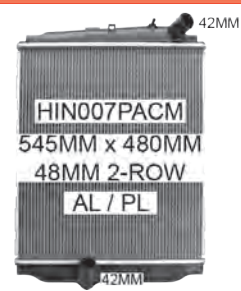

Header	494 x 69	Core	
O Ring/Gasket	OR495X66R	T/B Tank	HIN007PT
Condenser			
Notes	XZU304 / XZU347R		

DYNA 300 Series Man. '07-



8MM 42MM
HIN007PACMK
545MM x 480MM
48MM 2-ROW
AL/PL
42MM

Header	494 x 69	Core	
O Ring/Gasket	OR495X66R	T/B Tank	HIN007PT
Condenser			
Notes	XZU304 / XZU347R		

DYNA XZU341 Man. '99-04



38MM
HIN007PACM3K
545MM x 480MM
48MM 2-ROW
AL/PL
42MM

Header	494 x 69	Core	
O Ring/Gasket	OR495X66R	T/B Tank	
Condenser			
Notes	15B Engine		

DYNA XZU302 Man. '01-



38MM
HIN007PACM3K
545MM x 480MM
48MM 2-ROW
AL/PL
42MM

Header	494 x 69	Core	
O Ring/Gasket	OR495X66R	T/B Tank	
Condenser			
Notes	15B Engine		

DYNA 400 Series Auto. '05-07



42MM
HIN078PACA
600MM x 565MM
37MM 3-ROW
AL / PL
42MM

Header	581 x 54	Core	HIN078PA
O Ring/Gasket	OR582X55S	T/B Tank	HIN078PT
Condenser			
Notes			

DYNA 400 Series Man. '05-07



10MM 42MM
HIN078PACM
600MM x 565MM
37MM 2-ROW
AL/PL
42MM

Header	581 x 54	Core	HIN078PA
O Ring/Gasket	OR582X55S	T/B Tank	HIN078PT/PB
Condenser			
Notes			

DYNA XZU400/410 Man. '99-02



42MM
HIN010PACM
525MM x 565MM
36MM 2-ROW
AL/PL
42MM

Header	582 x 55	Core	
O Ring/Gasket		T/B Tank	
Condenser			
Notes			

DYNA XZU411 Auto. '00-03



8MM 42MM
HIN010PACA2
525MM x 550MM
36MM 2-ROW
AL/PL
42MM 250MM

Header	582 x 55	Core	
O Ring/Gasket		T/B Tank	
Condenser			
Notes			

DYNA YY201 / YY211 Auto. '95-00



34MM 34MM 390MM
TOY160CA
387MM x 520MM
32MM 2-ROW
CU/PL

Header	544 x 70	Core	
O Ring/Gasket		T/B Tank	
Condenser			
Notes			

FORKLIFT Auto.



Image Not Currently Available

TOY152PACA3

Header	446 x 85	Core	TOY152
O Ring/Gasket	OR446X85R	T/B Tank	
Condenser			
Notes			

FORKLIFT FG18 Man.



Header	463 x 47	Core	
O Ring/Gasket		T/B Tank	
Condenser			
Notes			

FORKLIFT FD25 / FD30T3 Auto.



Header	446 x 85	Core	TOY152
O Ring/Gasket	OR446X85R	T/B Tank	TOY015PB2/TOY152PBA
Condenser			
Notes			

FORKLIFT FD Series Auto.



Header	466 x 66	Core	
O Ring/Gasket		T/B Tank	
Condenser			
Notes			

FORKLIFT FG18



Header	463 x 47	Core	
O Ring/Gasket		T/B Tank	
Condenser			
Notes			

FORKLIFT FG20 / FG25 / FG30 Auto.



Header	446 x 85	Core	TOY152
O Ring/Gasket	OR446X85R	T/B Tank	TOY015PB2/TOY152PBA
Condenser			
Notes			

FORKLIFT FG25 Petrol Auto.



Header	446 x 85	Core	TOY014
O Ring/Gasket	OR446X85R	T/B Tank	
Condenser			
Notes			

FORKLIFT FG25 Petrol Auto.



Header	446 x 85 10mm FOH	Core	TOY014
O Ring/Gasket	OR446X85R	T/B Tank	
Condenser			
Notes			

FORKLIFT 5FD10-15 / 5FG10-15



Header	463 x 47	Core	
O Ring/Gasket		T/B Tank	
Condenser			
Notes			

FORKLIFT 5FD60/70/80 Auto.



Header	544 x 75	Core	
O Ring/Gasket	OR544X75R	T/B Tank	
Condenser			
Notes			

FORKLIFT 6 FG15/16 Auto.



Header	446 x 85 10mm FOH	Core	TOY015
O Ring/Gasket	OR446X85R	T/B Tank	TOY015PT/PBA
Condenser			
Notes			

FORKLIFT 7 Series Auto. '96-



Header	466 x 66	Core	
O Ring/Gasket		T/B Tank	
Condenser			
Notes			

FORKLIFT 7 Series Auto. '96-



Header	466 x 66	Core	
O Ring/Gasket		T/B Tank	
Condenser			
Notes			

FORKLIFT 7FG10 '99-



Header	446 x 58	Core	
O Ring/Gasket		T/B Tank	
Condenser			
Notes			

FORKLIFT 7FG020 / 7FG030 / 7FD020 / 7FD030 Auto.



Header	446 x 85	Core	TOY152
O Ring/Gasket	OR446X85R	T/B Tank	
Condenser			
Notes			

FORKLIFT 7FG25 Auto.

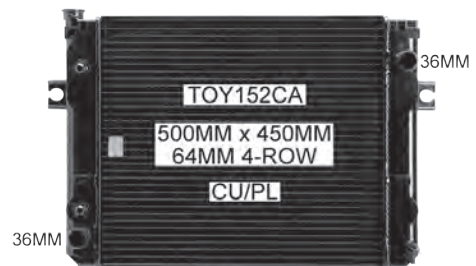

Header	446 x 85	Core	TOY152
O Ring/Gasket	OR446X85R	T/B Tank	TOY015PB2/TOY152PBA
Condenser			
Notes	Heavy Duty		

TOYOTA

FORKLIFT 7FG25/15 Auto. '98-02



Header	446 x 48	Core	
O Ring/Gasket		T/B Tank	TOY138PT
Condenser			
Notes			

FORKLIFT 7FG25/15 Auto. '98-02



Header	440 x 64	Core	
O Ring/Gasket		T/B Tank	
Condenser			
Notes			

FORKLIFT 8FG / 8FD Auto.



Header	446 x 48	Core	
O Ring/Gasket		T/B Tank	TOY138PT
Condenser			
Notes			

FORKLIFT 8FG / 8FD Auto.



Header	440 x 64	Core	
O Ring/Gasket		T/B Tank	
Condenser			
Notes			

VOLKSWAGEN

VOLKSWAGEN

CRAFTER 2EF1/2 2.5ltr Turbo Diesel Man. '07-



Header	415 x 50	Core	
O Ring/Gasket		T/B Tank	
Condenser	CMER70K		
Notes	Outlet Fitting is Clip On		

LT35/46 2.5ltr / 2.8ltr Turbo Diesel Man. '03-06



Header	415 x 50	Core	
O Ring/Gasket		T/B Tank	
Condenser			
Notes			

TRANSPORTER T3 Auto. '84-93



Header	454 x 48	Core	AUD009
O Ring/Gasket		T/B Tank	
Condenser			
Notes	External Oil Cooler		

TRANSPORTER T4 2.0ltr/2.5ltr/2.4D Man. '93-9/96



Header	378 x 46	Core	AUD014
O Ring/Gasket		T/B Tank	
Condenser	CVWN17		
Notes	External Oil Cooler / Also suit 2.5ltr Auto.		

TRANSPORTER T5 2.0ltr/1.9TDI Auto. '8/04-10



Header	488 x 56	Core	
O Ring/Gasket		T/B Tank	
Condenser	CVWN16		
Notes	1 x Sensor Hole / External Oil Cooler		

TRANSPORTER T5 2.0ltr/1.9TDI Man. '8/04-10



Header	490 x 46	Core	
O Ring/Gasket		T/B Tank	
Condenser	CVWN16		
Notes	1 x Sensor Hole		

TRANSPORTER T5 2.5ltr Turbo Diesel Auto. '8/04-10



Header	490 x 46	Core	
O Ring/Gasket		T/B Tank	
Condenser	CVWN16		
Notes	1 x Sensor Hole / External Oil Cooler / Also suit Man.		

TRANSPORTER T5 3.2ltr V6 Auto. '8/04-08



Header	488 x 56	Core	
O Ring/Gasket		T/B Tank	
Condenser	CVWN16		
Notes	1 x Sensor Hole / External Oil Cooler		

TRANSPORTER T5 Auto. '3/10-



Header		Core	
O Ring/Gasket		T/B Tank	
Condenser	CVWN16		
Notes	Outlet Located on Grille Side / Suits both Turbo & Twin Turbo Engines		

VOLVO

B10M BUS Man.



Header	580 x 70	Core	
O Ring/Gasket		T/B Tank	
Condenser			
Notes			

VOLKSWAGEN

VOLVO

VOLVO

B12 BUS Man. '08-



Header	830 x 74	Core	
O Ring/Gasket		T/B Tank	
Condenser			
Notes	DH12 Engine		

FL6 Man. '95-00



Header	568 x 69	Core	VOL009PA
O Ring/Gasket		T/B Tank	
Condenser			
Notes			

F10 / F12 Man.



Header	809 x 100	Core	VOL916
O Ring/Gasket		T/B Tank	
Condenser	CVOL25		
Notes			

FE Man. '08-



Header		Core	
O Ring/Gasket		T/B Tank	
Condenser			
Notes			

FH12 Man. '97-



Header	910 x 81	Core	VOL006
O Ring/Gasket	OR910X81F	T/B Tank	VOL006PT/PB
Condenser	CVOL25		
Notes			

FH12 Man. '97-



Header	752 x 82	Core	VOL007
O Ring/Gasket	OR752X81R	T/B Tank	VOL007PT/PB
Condenser	CVOL25		
Notes			

FH16 Man. '97-



Header	910 x 81	Core	VOL006
O Ring/Gasket	OR910X81F	T/B Tank	VOL006PT/PB
Condenser			
Notes			

FL6 Auto. '02-



Header	565 x 70	Core	
O Ring/Gasket		T/B Tank	
Condenser			
Notes	5480cc		

FM12 Man. '98-



Header	758 x 80	Core	
O Ring/Gasket		T/B Tank	
Condenser	CVOL25		
Notes	420hp		

NH16 Man. '97-



Header	910 x 81	Core	VOL006
O Ring/Gasket	OR910X81F	T/B Tank	VOL006PT/PB
Condenser			
Notes			

VOLVO

VHD Auto.

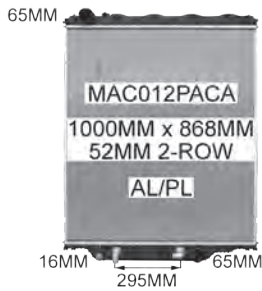

Header	890 x 70	Core	
O Ring/Gasket	OR893X72R	T/B Tank	MAC012PT/PBA
Condenser			
Notes			

VHD Auto.

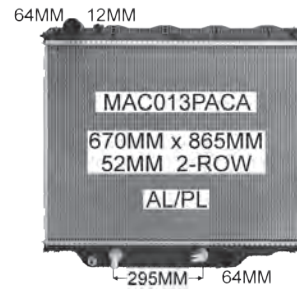

Header	890 x 70	Core	
O Ring/Gasket	OR893X72R	T/B Tank	MAC012PT/PBA
Condenser			
Notes			

VT / VT2 Auto. '04-



Header	890 x 69	Core	
O Ring/Gasket	OR893X72R	T/B Tank	MAC012PT/PBA
Condenser			
Notes			

Header		Core	
O Ring/Gasket		T/B Tank	
Condenser			
Notes			

WESTERN STAR

4800 Series Man. '10-



Header	1076 x 85	Core	
O Ring/Gasket		T/B Tank	
Condenser			
Notes	Detroit DD13 Engine		

WESTERN STAR

WESTERN STAR

4800FX Man. '11-



Header	1076 x 85	Core	
O Ring/Gasket		T/B Tank	
Condenser			
Notes	Cummins ISX Engine		

4800FX Man. '11-



Header	1076 x 85	Core	
O Ring/Gasket		T/B Tank	
Condenser			
Notes	Detroit DD15 Engine		

YALE

YALE

FORKLIFT GLP15AF Auto.



Header	460 x 70	Core	
O Ring/Gasket		T/B Tank	
Condenser			
Notes			

KENWORTH QUICK REFERENCE OE PARTS GUIDE

Assembly Part No.	Application(s)	Tank		Side Support		Reo Bar		Gasket	Cross Brace	Fan Shroud
		Top	Bottom	Left	Right	Long	Short			
AKW-2355	T650	VLF1002	K194-2-1783	T100005A		K305-105	K305-121	K134-298	T000012B/K	K078-194
AKW-2357	K100E	VLF1002	K194-2-1783	T100005A		K305-105	K305-121	K134-298	T000012B/K	K078-194
AKW-2370	T600	VHF1005	K194-1705	T200004L	T200004R	SP-1309	SP-1311	SP-1289	T000012B/K	
AKW-2375	T400,T450	VHF1005	K194-1705	T200004L	T200004R	SP-1309	SP-1311	SP-1289	T000012B/K	
AKW-2376	WSeries	MLF1032	K194-1751B	K194-4-1800L	K194-4-1800R	K305-102	K305-121	SP-1992	K046-1624	
AKW-2378	C500GL,C500T	SP-3266/6MLF95C	K194-2-1751B	K194-4-1800L	K194-4-1800R	K305-102	K305-121	SP-1992	K046-1624	
AKW-2427	T900	VHF1005	T200022A	T200004L	T200004R	SP-1309	SP-1311	SP-1289	T000012B/K	
AKW-2434	T400,T450	VHF1023	T210003A	T210001AL	T210001AR	SP-1307	SP-1311	SP-1287	T210019A	T210004A
AKW-2435	T600	VHF1005	T200022A	T200011A	T200103R	SP-1309	SP-1311	SP-1289		Provide Serial No.
AKW-2436	K100E	VHF1005	T200033A	T200018A	T200004L	SP-1309	SP-1311	SP-1289		Provide Serial No.
AKW-2464	T900,T950	VHF1005	T200006A	T200005A	T200112L	SP-1309	SP-1311	SP-1289		Provide Serial No.
AKW-2465	T650	VHF1005	T200022A	K194-1709	T200004R	SP-1309	SP-1311	SP-1289		Provide Serial No.
AKW-2478	T900,T950	MLF1554/K	T200006A	T200005A	T200112L	SP-1309	SP-1311	SP-1289		Provide Serial No.
AKW-2496	C500T	SP-3266/6MLF95C	K194-2-1751B	K194-4-2496L	AKW-4-2496R	K305-102	K305-121	SP-1992	K046-1624	
ARO-2384	C500T	VLF1008	T300010A	T300011A	AKW-4/1-2358	SP-250	SP-1491	SP-2512		T300007A
TLD10030	T400,T450	VHF1023	T210003A	T210005A	T210001AL	SP-1307	SP-1311	SP-1287	T210019A	T210004A
TLD10040	T900	VHF1005	T200022A	T200004L	T200004R	SP-1309	SP-1311	SP-1289		
TLD10050	T600	VHF1005	T200022A	T200011A	T200103L	SP-1309	SP-1311	SP-1289	T000012B/K	Provide Serial No.
TLD10051	T600	MLF1554/K	T200022A	T200011A	T200103R	SP-1309	SP-1311	SP-1289	T000012B	Provide Serial No.
TLD10070	K100E	VHF1005	T200033A	T200018A	T200004L	SP-1309	SP-1311	SP-1289	T000012B/K	Provide Serial No.
TLD10071	K100E,K100G	MLF1554/K	T200033A	T200018A	T200004L	SP-1309	SP-1311	SP-1289	T000012B/K	Provide Serial No.
TLD10080	T900,T950	VHF1005	T200006A	T200005A	T200112L	SP-1309	SP-1311	SP-1289	T000012B/K	Provide Serial No.
TLD10081	T900,T950	MLF1554/K	T200006A	T200005A	T200112L	SP-1309	SP-1311	SP-1289	T000012B/K	Provide Serial No.
TLD10090	T650	VHF1005	T200022A	K194-1709	T200004L	SP-1309	SP-1311	SP-1289	T000012B/K	Provide Serial No.
TLD10091	T650	MLF1554/K	T200022A	K194-1709	T200004L	SP-1309	SP-1311	SP-1289	T000012B/K	Provide Serial No.
TLD11440	T400,T450	VHF1456	T210026A	T210027A	T210032A	SP-1307	SP-1311	SP-1287		T210025A
TLD13850	T600	VHF1005	T200006A	T200128A	T200103L	SP-1309	SP-1311	SP-1289	T000012B/K	Provide Serial No.
TLD13851	T600	MLF1554/K	T200006A	T200128A	T200103R	SP-1309	SP-1311	SP-1289	T000012B	Provide Serial No.
TLD15400	T600	MLF1492	T200022A	T200001A	T200103L	SP-1309	SP-1311	SP-1289		Provide Serial No.
TLD16850	T650	MLF1554/K	T200022A	K194-1709	T200103R	SP-1309	SP-1311	SP-1289	T000012B	Provide Serial No.
TLD18040	T900,T950	MLF1509	T220038A	T220023A	T220039A	SP-2522	SP-1311	SP-2506		T220044A
TLD18050	C500,C501	MLF1509	T220047A	T220023A	T220039A	SP-2522	SP-1311	SP-2506		T220045A
TLD18100	T650	MLF1498	T220048A	K194-1709	T200103L	SP-1309	SP-1311	SP-2506		T220046A
TLD18110	C500,C501	MLF1110	T220001A	T220002A	T220003L	SP-2252	SP-1311	SP-2506	T220004A	K216-1993
TLD18170	K100E	VHF1005	T200119A	T200120A	T200121L	SP-1309	SP-1311	SP-1289		
TLD18170	K100E	VHF1005	T200124A	T200018A	T200004L	SP-1309	SP-1311	SP-1289		K216-1998
TLD18360	C500,C501	MLF1110	T220022A	T220023A	T220003L	SP-2522	SP-1311	SP-2506		T220027A
TLD18360	K100E,K100G	MLF1554/K	T200119A	T200120A	T200121L	SP-1309	SP-1311	SP-1289	T000012B	Provide Serial No.
TLD18550	T600	VHF1005	T200131A	T200011A	T200103L	SP-1309	SP-1311	SP-1289		Provide Serial No.
TLD18620	C500,C501,T900,T950	MLF1110	T220022A	T220023A	T220031A	SP-2522	SP-1311	SP-2506		Provide Serial No.
TLD18620	C500,C501	MLF1032	K194-2-1751B	K194-4-1800L	K194-4-1800R	K305-102	K305-121	SP-1992	K046-1624	K216-2061
TLD186740	L700	MLF1493	T200138A	T200139A	T200140L	SP-1307	SP-1311	SP-1287		
TLD187120	T900,T950	VHF1512	T220022A	T220023A	T220003L	SP-2522	SP-1311	SP-2506	T220004A	Provide Serial No.

KENWORTH QUICK REFERENCE OE PARTS GUIDE

Assembley Part No.	Application(s)	Core	Tank		Side Support			Reo Bar		Gasket	Cross Brace	Fan Shroud
			Top	Bottom	Left	Right	Long	Short				
TLW17121	T900,T950	MLF1558	T220022A	T220023A	T220003L	T220003R	SP-2522	SP-1311	SP-2506	T220004A	Provide Serial No.	
TLW17390	K100,K120	VHF1514	T200146A	T200120A	T200004L	T200162A	SP-1309	SP-1311	SP-1289	T220043A	T220043A	
TLW17750	T600,T601	MLF1554/K	T200022A	T200149A	T200103L	T200103R	SP-1309	SP-1311	SP-1289	T220044A	K216-1995	
TLW17780	C500	MLF1504	T220022A	T220023A	T220037A	T220037A	SP-2522	SP-1311	SP-2506	T220045A	T220045A	
TLW17781	C500	SLF1505	T220022A	T220023A	T220037A	T220037A	SP-2522	SP-1311	SP-2506	T220046A	T220046A	
TLW18110	T650	MLF1498	T220048A	K194-1709	T200103L	T200153A	SP-1309	SP-1311	SP-1289	T220043A	T220043A	
TLW18130	K100	VHF1514	T200146A	T200120A	T200004L	T200162A	SP-1309	SP-1311	SP-1289	T220044A	T220044A	
TLW18140	T900,T950	MLF1509	T220038A	T220023A	T220039A	T220039A	SP-2522	SP-1311	SP-2506	T220045A	T220045A	
TLW18150	C500,C501	MLF1509	T220047A	T220023A	T220039A	T220039A	SP-2522	SP-1311	SP-2506	T220045A	T220045A	
TLW18660	T600,T601	VHF1514	T200158A	T200128A	T200103L	T200103R	SP-1309	SP-1311	SP-1289	T220045A	K216-2050	
TLW18670	T650	VHF1514	T200152A	T200156A	T200153A	T200103R	SP-1309	SP-1311	SP-1289	T220045A	K216-2050	
TLW18950	C500,C501	MLF1509	T220071A	T220023A	T220039A	T220039A	SP-2522	SP-1311	SP-2506	T220044A	Provide Serial No.	
TLW19030	C500T,C501	VHF1512	T220072A	T220023A	T220003L	T220003R	SP-2522	SP-1311	SP-2506	T220044A	Provide Serial No.	
TLW19540	T401/T601	MLF1082	T200165A	T200128A	T200103L	T200103R	SP-1309	SP-1311	SP-1289	T220529B	T220529B	
TLW19910	K100G,T404,T480,T601	MLF1082	T200165A	T200128A	T200168L	T200168R	SP-1309	SP-1311	SP-1289	T000012B/K	T000012B/K	
TLW20360	T650	MLF1525	T200165A	T200128A	T200172L	T200172R	SP-1309	SP-1311	SP-1289	T000025B	Provide Serial No.	
TLW20361	T650	MLF1548	T200165A	T200128A	T200172L	T200172R	SP-1309	SP-1311	SP-1289	T000025B	Provide Serial No.	
TLW20730	C500	MLF1110	T220086A	T220023A	T220092A	T220092A	SP-2522	SP-1311	SP-2506	T210075A	T210075A	
TLW21140	C500	MLF1110	T220098A	T220023A	T220100A	T220100A	SP-2522	SP-1311	SP-2506	K216-2064	K216-2064	
TLW21310	C500T	MLF1110	T220022A	T220002A	T220102A	T220102A	SP-2522	SP-1311	SP-2506	T210075A	T210075A	
TLW21500	C500,C501	MLF1053	K194-2-1751B	K194-1673	K194-4-1800L	K194-4-1800R	SP-1309	SP-1311	K305-102	Provide Serial No.	Provide Serial No.	
TLW21590	K100E	MLF1554/K	T200175A	T200120A	T200121L	T200121R	SP-1309	SP-1311	SP-1289	K216-1999	K216-1999	
TLW21650	T600,T650	VLF1002	K194-2-1783	K194-3-1783	T100005A	T100005A	K305-105	K305-121	K134-298	T000012B/K	Provide Serial No.	
TLW21910	K100G	MLF1554/K	T200119A	T200128A	T200121L	T200121R	SP-1309	SP-1311	SP-1289	T000012B/K	Provide Serial No.	
TLW21911	K100G	VHF1514	T200119A	T200128A	T200121L	T200121R	SP-1309	SP-1311	SP-1289	T000012B/K	Provide Serial No.	
TLW22280	T300,T900	VHF1533	T900009A	T900009A	T900010A	T900011A	SP-1305	SP-1311	SP-1285	T900012A	T900012A	
TLW23061	K100,K104	VHF1514	T200119A	T200179A	T200121L	T200121R	SP-1309	SP-1311	SP-1289	T000025B	T000025B	
TLW23062	K100G	MLF1554	T200119A	T200179A	T200121L	T200121R	SP-1309	SP-1311	SP-1289	T000025B	T000025B	
TLW23070	K100G	VHF1514	T200175A	T200179A	T200121L	T200121R	SP-1309	SP-1311	SP-1289	T000012B	Provide Serial No.	
TLW23170	C500T	VHF1512	T220110A	T220002A	T220102A	T220102A	SP-2522	SP-1311	SP-2506	K216-2074	K216-2074	
TLW23520	C500T	MLF1110	T220086A	T220023A	T220102A	T220102A	SP-2522	SP-1311	SP-2506	T220109A	T220109A	
TLW23610	T600,T601	VHF1514	T200158A	T200128A	T200168L	T200168R	SP-1309	SP-1311	SP-1289	T220111A	T220111A	
TLW23670	T300	VHF1533	T900009A	T900009A	T900018A	T900018A	SP-1305	SP-1311	SP-1285	K216-02050	K216-02050	
TLW23671	T300	VHF1541	T900009A	T900009A	T900018A	T900018A	SP-1305	SP-1311	SP-1285	T900012A	T900012A	
TLW24030	T601	VHF1514	T200158A	T200128A	T200168L	T200168R	SP-1309	SP-1311	SP-1289	T000012B	T000012B	
TLW24070	T650	MLF1525	T200165A	T200128A	T200172L	T200172R	SP-1309	SP-1311	SP-1289	T000025B	Provide Serial No.	
TLW24200	K100E	MLF1554/K	T200175A	T200179A	T200121L	T200121R	SP-1309	SP-1311	SP-1289	T000012B/K	Provide Serial No.	
TLW24210	T300	VHF1533	T900022A	T900028A	T900024A	T900024A	SP-1305	SP-1311	SP-1289	T900012A	Provide Serial No.	
TLW24211	T300	VLF1540	T900022A	T900028A	T900023A	T900023A	SP-1305	SP-1311	SP-1289	T900012A	Provide Serial No.	
TLW24430	C500	MLF1110	T220086A	T220113A	T220092L	T220092R	SP-2522	SP-1311	SP-2506	T220112A	T220112A	
TLW24670	K100G	VHF1514	T200185A	T200179A	T200121L	T200121R	SP-1309	SP-1311	SP-1289	Provide Serial No.	Provide Serial No.	
TLW24780	T650	MLF1548	T200165A	T200128A	T200172L	T200172R	SP-1309	SP-1311	SP-1289	Provide Serial No.	Provide Serial No.	
TLW25000	K100,K104	MLF1554	T220150A	T200179A	T200121L	T200121R	SP-1309	SP-1311	SP-1289	Provide Serial No.	Provide Serial No.	

KENWORTH QUICK REFERENCE OE PARTS GUIDE

Assembly Part No.	Application(s)	Core	Tank		Side Support		Reo Bar		Gasket	Cross Brace	Fan Shroud
			Top	Bottom	Left	Right	Long	Short			
TLW25130	T604,T650	MLF1557	T220155A	T220156A	T220154L	T220154R	SP-1310	SP-1311	SP-1290	T220157A/K	
TLW25560	T900,T950	MLF1558	T220022A	T220023A	T220003L	T220003R	SP-2522	SP-1311	SP-2506	T220004A	Provide Serial No.
TLW25570	C500,C501	MLF1558	T220072A	T220023A	T220003L	T220003R	SP-2522	SP-1311	SP-2506	T220004A	Provide Serial No.
TLW26890	K100G	MLF1554/K	T200033A	T200188A	T200004L	T200004R	SP-1309	SP-1311	SP-1289		T220183A
TLW27060	K100G	MLF1554/K	T200175A	T200179A	T200121L	T200121R	SP-1309	SP-1311	SP-1289	T000012B	Provide Serial No.
TLW27110	T904	MLF1558	T220072A	T220023A	T220003L	T220003R	SP-2511	SP-1311	SP-2504	T220004A	T220185A
TLW27800	T404	MLF1554/K	T200158A	T200196A	T200198L	T200198R	SP-1309	SP-1311	SP-1289	T000012B	T220192A
TLW28260	T904,T950	MLF1558	T220072A	T220023A	T220003L	T220003R	SP-2522	SP-1311	SP-2506	T220004A	Provide Serial No.
TLW29870	C510	MLF1678	T220200A	T220201A	T220202L	T220202R	SP-2524	SP-1311	SP-2508	T220203B	
TLW32070	C501	MLF1558	T220072A	T220023A	T220003L	T220003R	SP-2522	SP-1311	SP-2506	T220004A	
TLW32150	T650	MLF1525	T200165A	T200128A	T200202A	T200172R	SP-1309	SP-1311	SP-1289	T000025B	
TLW32310	T904	MLF1558	T220216A	T220023A	T220003L	T220003R	SP-2522	SP-1311	SP-2506	T220004A	
TLW32370	C500T	MLF1110	T220220A	T220113A	T220003L	T220003R	SP-2522	SP-1311	SP-2506	T220004A	
TLW32902	T404	MLF1554	T200217A	T200196A	T200198L	T200198R	SP-1309	SP-1311	SP-1289	T000012B/K	
TLW33010	K104B	MLF1554/K	T200209A	T200179A	T200121L	T200121R	SP-1309	SP-1311	SP-1289	T000012B/K	
TLW33020	K104	MLF1554/K	T200210A	T200179A	T200121L	T200121R	SP-1309	SP-1311	SP-1289	T000012B/K	
TLW33030	T904,T950	MLF1558	T220224A	T220023A	T220003L	T220003R	SP-2522	SP-1311	SP-2506	T220004A	
TLW33032		MLF1558	T220224A	T220023A	T220003L	T220003R	SP-2522	SP-1311	SP-2506	T220004A	
TLW33090	T604,T650	MLF1557	T220155A	T220156A	T220223L	T220223R	SP-1310	SP-1311	SP-1290	T220004A	
TLW38650	T404	MLF1554	T200217A	T200222B	T200198L	T200223R	SP-1309	SP-1311	SP-1289	T000012B/K	
TLW38651	T404	MLF1554/K	T200217A	T200230B	T200198L	T200233R	SP-1309	SP-1311	SP-1289	T000012B/K	
TLW39202	T404	MLF1900	T220237A	T220238A	T220239L	T220239R	SP-2524	SP-1311	SP-2508	T000012B/K	
TLW41710	T908	MLF1900	T220237A	T220238A	T220239L	T220239R	SP-2524	SP-1311	SP-2508	T220304A	T220254A
TLW43540	T608,T650,T658	MLF1900	T220418A	T220416A	T220462L	T220462R	SP-2524	SP-1311	SP-2508	T220304A	T220459A
TLW43890	K108	MLF1948	T220315A	T220323A	T220326L	T220326R	SP-1309	SP-1311	SP-1289	T220304A	T220523A
TLW44980	T650	MLF1557	T220155A	T220358A	T220223L	T220223R	SP-1310	SP-1311	SP-1290		
TLW45310	T904	MLF1558	T220224A	T220023A	T220003L	T220003R	SP-2522	SP-1311	SP-2506	T220004A	
TLW46020	T404	MLF1554	T200217A	T200230B	T200198L	T200223R	SP-1309	SP-1311	SP-1289	T000012B/K	
TLW46120		MLF1558	T220364A	T220023A	T220003L	T220003R	SP-2522	SP-1311	SP-2506		
TLW47160	T408	MLF2009	T220388A	T220389A	T220390L	T220390R	SP-2524	SP-1311	SP-2508	T220404A	T220435A
TLW47590	T408	MLF2009	T220388A	T220408A	T220390L	T220390R	SP-2524	SP-1311	SP-2508	T220404A	T220410A
TLW48470	T408	MLF2009	T220425A	T220408A	T220390L	T220390R	SP-2524	SP-1311	SP-2508	T220404A	T220426A
TLW48480	C508	MLF2024	T220427A	T220428A	T220429L	T220429R	SP-2524	SP-1491	SP-2516	T000079B	T220430A
TLW48570	T408	MLF2009	T220437A	T220389A	T220390L	T220390R	SP-2524	SP-1311	SP-2508	T220404A	T220435A
TLW48780	T650,T658	MLF1900	T220444A	T220416A	T220462L	T220462R	SP-2524	SP-1311	SP-2508	T220404A	T220459A
TLW49840	K108	MLF1944	T220270A	T220271A	T220272L	T220272R	SP-1491	SP-1309	SP-1469	T220304A	T220468A
TLW50130	T408	MLF2009	T220483A	T220484A	T220390L	T220390R	SP-2524	SP-1311	SP-2508	T220404A	T220481A
TLW50680	K108	MLF1948	T220508A	T220509A	T220510L	T220510R	SP-1309	SP-1311	SP-1289	T220304A	T220511A
TLW51160	K108	MLF1554	T220534A	T200179A	T200121L	T200121R	SP-1309	SP-1311	SP-1289	T000012B/K	T220234A
TLW51240	K108	MLF1554	T220538A	T200179A	T200121L	T200121R	SP-1309	SP-1311	SP-1289	T000012B/K	T220539A
TLW52350	K104	MLF1948	T220551A	T220323A	T220326L	T220326R	SP-1309	SP-1311	SP-1289	T220304A	
TLW52520		MLF2115	T220427A	T220428A	T220429L	T220429R	SP-2524	SP-1491	SP-2516	T000079B	
TLW52810	T609,T659	MLF1900	T220561A	T220416A	T220462L	T220462R	SP-2524	SP-1311	SP-2508	T220304A	T220459A

KENWORTH QUICK REFERENCE

KENWORTH QUICK REFERENCE OE PARTS GUIDE

Assembly Part No.	Application(s)	Core	Tank		Side Support		Reo Bar		Gasket	Cross Brace	Fan Shroud
			Top	Bottom	Left	Right	Long	Short			
TLW52870	T409	MLF2009	T220656A	T220389A	T220390L	T220390R	SP-2524	SP-1311	SP-2508	T220404A	T220718A
TLW52880	T408	MLF2009	T220567A	T220408A	T220390L	T220390R	SP-2524	SP-1311	SP-2508	T220404A	
TLW53690	T909	MLF1900	T220576A	T220577A	T220578L	T220578R	SP-2524	SP-1311	SP-2508		T220571A
TLW57480	T409	MLF2009	T220567A	T220408A	T220390L	T220390R	SP-2524	SP-1311	SP-2508		T220426A
TLW57730	K109	MLF2177	T220655A	T220657A	T220656L	T220656R	SP-1309	SP-1491	SP-1469		F23-1104
TLW59620	K200	MLF2107	T220753A	T220626A	T220625L	T220625R	SP-1309	SP-1491	SP-1469	T220304A	F22-1103
TLW61670	C509	MLF2024	T220427A	T220800A	T220429L	T220429R	SP-2524	SP-1491	SP-2516		T220543A
TLW61910	T409	MLF2009	T220565A	T220822A	T220390L	T220390R	SP-2524	SP-1311	SP-2508		
TMC18380	C500	T18380	T220064A	T220067A	T220066A	T220065A	11838002	SP-1491	11838001		
TMQ15010	T440,T480	MLF1492	T210055A	T210056A	T210057A	T210058A	SP-1309	SP-1311	SP-1289	T210068B	Provide Serial No.
TMQ15011	T440,T480	MLF1554/K	T210055A	T210056A	T210057A	T210058A	SP-1309	SP-1311	SP-1289	T210068B	Provide Serial No.
TMQ15012	T401	MLF1554/K	T210055A	T210056A	T210057A	T210058A	SP-1309	SP-1311	SP-1389	T210068B	Provide Serial No.
TMQ23370	T440,T480	MLF1554/K	T210055A	T210056A	210057A	T210058A	SP-1309	SP-1311	SP-1289	T210068B	T210060A
TMR10060	C500T	VLF1008	T300010A	T300011A	AKW-4/1-2358	AKW-4/2-2358	SP-250	SP-1491	SP-2512		T300007A
TMR11600	C500T	VLF1008	T300010A	T300011A	AKW-4/1-2358	AKW-4/2-2358	SP-2520	SP-1491	SP-2512		
TMW18390	C500	T18390	T220055A	T220056A	T220057A	T220058A	SP-1305	SP-1491	SP-1465		
TMW24280	C510	MLF1543	12428001	12428002	12428007	1248008	SP-2524	SP-1491	SP-2516	12428016	
TMW24290	C510	MLF1544	12429001	12429002	12429007	12429005	SP-2524	SP-1311	SP-2508		
TMW34970	T350,T351,T352,T353,T354	MLF1492	T210095A	T210097A	T210057A	T210096A	SP-1309	SP-1311	SP-1289	T210068B	
TMW34971	T401	MLF1082	T210095A	T210097A	T210057A	T210096A	SP-1309	SP-1311	SP-1289	T210068B	
TMW34972	T401	MLF1554	T210095A	T210097A	T210057A	T210096A	SP-1309	SP-1311	SP-1289	T210068B	
TMW40170	T350	MLF1492	T210095A	T210097A	T210057A	T210100A	SP-1309	SP-1311	SP-1289	T210068B	
TMW40171	T350	MLF1082	T210095A	T210097A	T210057A	T210100A	SP-1309	SP-1311	SP-1289	T210068B	
TMW42960		MLF1082	T210104A	T210097A	T210057A	T210100A	SP-1309	SP-1311	SP-1289	T210068B	
TMW42961		MLF1492	T210104A	T210097A	T210057A	T210100A	SP-1309	SP-1311	SP-1289	T210068B	
TMW44280	T950	MLF1492	T210104A	T210097A	T210057A	T210096A	SP-1309	SP-1311	SP-1289	T210068B	
TMW44580		MLF1554	T210104A	T210097A	T210057A	T210100A	SP-1309	SP-1311	SP-1289	T210068B	
TMW50060	T350	MLF1554	T210104A	T210097A	T220503A	T220504A	SP-1309	SP-1311	SP-1289	T220497B	T220499A
TMW51010	T388	MLF2081	T220525A	T220524A	T220526A	T220527A	SP-2520	SP-1311	SP-2504	T220529B	T220546A
TMW59740	T403	MLF2081	T220600A	T220599A	T220526A	T220527A	SP-2520	SP-1311	SP-2504	T220529B	
TMW60350	T359	MLF1554	T210104A	T210097A	T210057A	T210100A	SP-1309	SP-1311	SP-1289		
TMW60750	T403	MLF2081	T220599A	T220600A	T220526A	T220527A	SP-2520	SP-1311	SP-2504		T220545A
TMW61950	T359	MLF1492	T210097A	T210104A	T210096A	T210057A	SP-1309	SP-1311	SP-1289		